

# Structural Dynamic Response of a Track Chain Complete Undercarriage System using Virtual Proving Ground Approach

Marco Perillo\*, Vito Primavera\*, Giorgio Bonello, Marco Cavedoni \*\*

\*EnginSoft SpA, Via A. Murri, 2 – Z.I., 72023 Mesagne, Brindisi, Italy

\*\* Italtractor ITM Spa, Via Confortino, 23/28, 40010 Crespellano, Loc. Calcara, Bologna, Italy

## Abstract

*ITM Group Engineering Department uses advanced tools as finite element method for static structural analyses of undercarriages, side frames or undercarriage components, as track chain, rollers and tension devices. In order to integrate the recent prototype concepts into this design process combining full system real time dynamic simulations able to represent a typical situation due to operation manoeuvre, experimental test information and 30 years experience of ITM group, a new design procedure is proposed to design and to develop complete undercarriage systems. This paper focuses on the employ of the explicit finite element code LS-DYNA<sup>®</sup> for predicting reliably the structural behavior of a track chain undercarriage system during usual road obstacles impacts and on the following fatigue life damage analyses of undercarriage (frame components using eta/VPG concept and tools. Part of activity is also developed to investigate how the new simulation procedure could be implemented into ITM Group Engineering Department for increasing design chain efficiency. While the big technical challenge is related to model representation of particular components and to the application of standard operating conditions. Stress and strain field results for full structure and its components are presented and fatigue life of frame principal component is determined and its integrity is evaluated. Finally merits and limits analysis is made in term of quality simulation results, numerical model complexity, design procedure efforts and computational time consuming in comparison to ITM Group Engineering Department experiences.*

## Introduction

The goal of this work is to build up a new design procedure able to predict accurately structural responses of a track chain undercarriage system, starting from 3D parametrical CAD models and exploiting the FEM analyses to investigate and point out the characteristic dynamic phenomena under the working conditions. The activities logic flow were developed taking into account the ITM group technical and logistic requirements with the aim to maximize the time efficiency of the new procedure and not only his effectiveness. For these reasons, the initial set-up of the FEM models has been carried out by using the Ansys/WB environment that presents a parametrical CAD data integration and an easy-to-use hexahedral mesh tool. For model implementation and analyses launch preparations eta/VPG set of tools are used. Particularly it is used for mechanical system creation, contact definition, boundary and initial conditions conception.

Dynamic analyses have been performed by using the explicit finite element code LS-DYNA<sup>®</sup> while, for prediction of durability due to critical proving ground events, final fatigue response assessment using the eta/VPG fatigue/durability tool.

## **Methodology description**

The basic idea behind the development of new design procedure suggested for a track chain undercarriage system, was to build up a methodology able to point out which CAE tool is needed to perform every single step of the design, how these tools can be integrated into a single work flow and if the whole procedure can be fitted into the ITM group process design.

According to this approach, the activity were divided into four main phases:

Phase 1 – Assessment of the numerical models, meshing every component in Ansys/WB (from original parametrical 3D CAD files) and eta/VPG complete model implementation (component or sub-system joining, vehicle dynamic fixing, etc.);

Phase 2 – FEM simulation of a typical event of the working conditions by using the explicit finite element code LS-DYNA<sup>®</sup> (the eta/VPG code was used as pre-processor for LS-DYNA<sup>®</sup>);

Phase 3 – Fatigue validation of the more critical parts using the eta/VPG code;

Phase 4 – Methodology Feasibility.

## **Numerical models and applications**

The set-up of the numerical models was mainly carried on in phase 1 for the study regarding the system structural behavior during usual road obstacles impacts, and in phase 3 for the investigation related to the fatigue analysis.

In the initial step, the original CAD models were fixed with the aim to get their compatibility with FEM analyses (Fig. 1). This required to import and repair into Ansys/WB the single CAD models of the track group with shoes (Fig. 2), roller, sprocket, idler, frame and tension devices. Later on, all the different parts were meshed with hexaedrical elements (meshed parts are shown in Fig. 2-4). Once imported into eta/VPG, the whole meshed model can be sketched as in Fig. 4, while Fig. 5 sketches the two rollers located in the inner part of the frame.

The geometry of some elements is not related to the model accuracy, and consequently only their functionality has to be taken into account, as elements like joints and preload spring.

The preload spring was modeled by using a beam, characterized by a preload = 30 kN, a stiffness  $K = 4320$  N/mm and a damping  $C = 50$  N s/mm. The relative rotations between the track chains were implemented by using the keyword card \*CONSTRAINED\_JOINT\_REVOLUTE, according to the track chains rotate relative to each other along the axis defined by the common edge.

In the last step of this first phase, the working conditions of the track chain undercarriage system were assessed. The initial forces acting on the system were the external gravity and the internal spring preload, therefore, before to evaluate the system dynamic response, a preliminary analysis was performed with the scope to get the system equilibrium at time zero. Fig. 6 shows a comparison between the unloaded and loaded system.

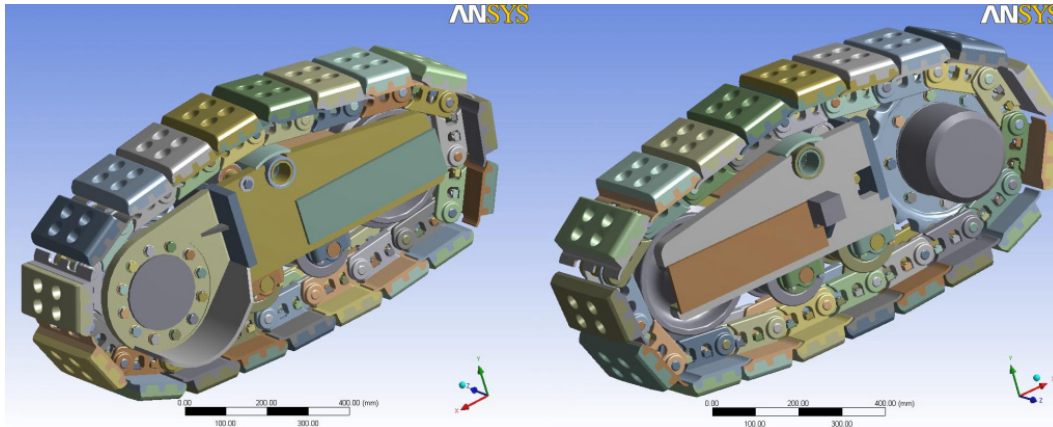

Fig.1: CAD model of complete system

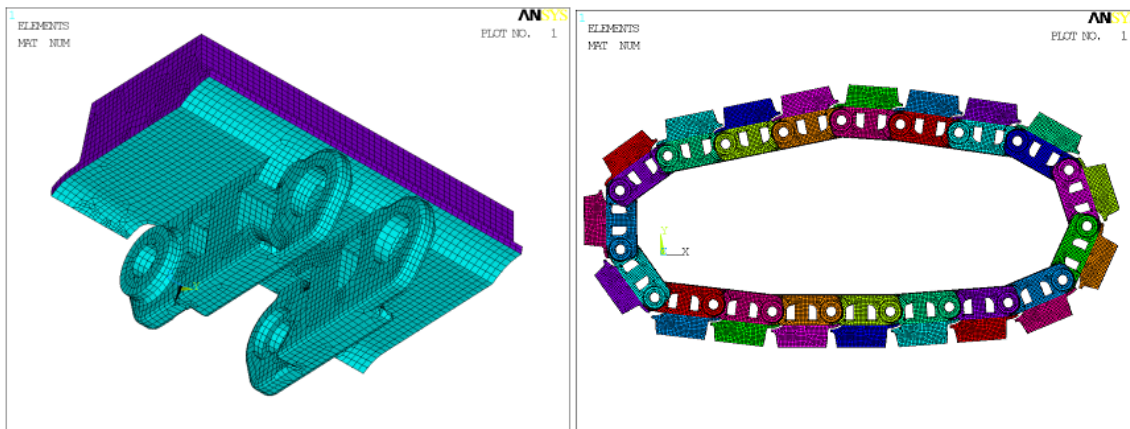

Fig.2: Track with shoes and complete chain FEM models

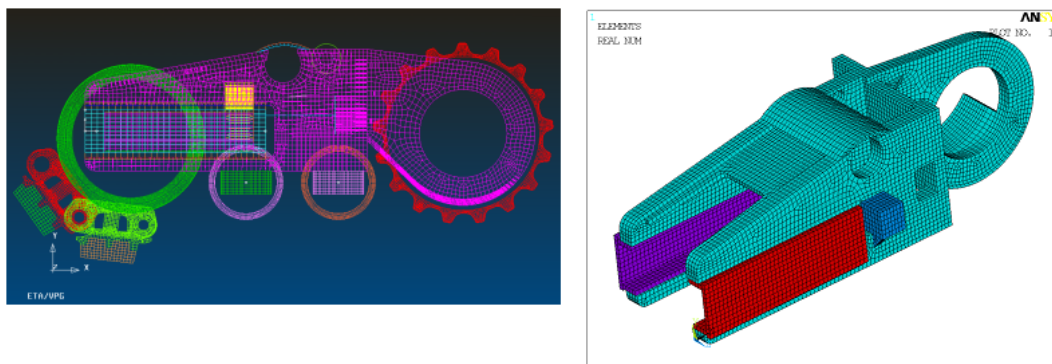

Fig.3: Frame FEM model

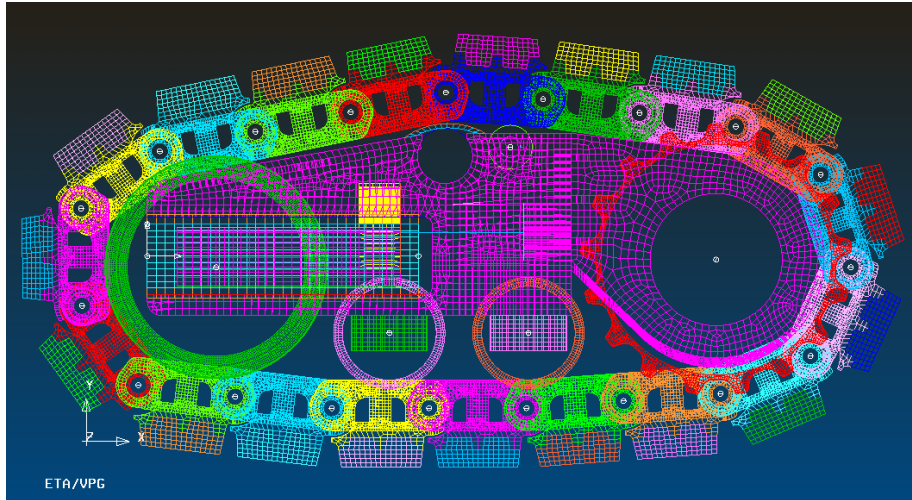
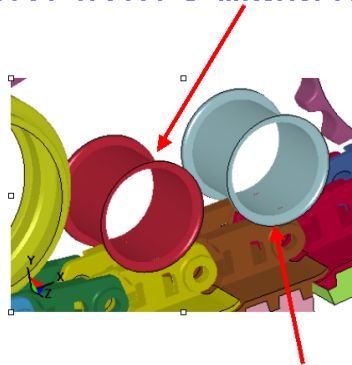

Fig.4: Model assembly of all meshed parts

A JT-475161 → anterior roller



B JT-475162 → posterior roller

Fig.5: Rollers positioning

LS-DYNA user input  
Time = 0

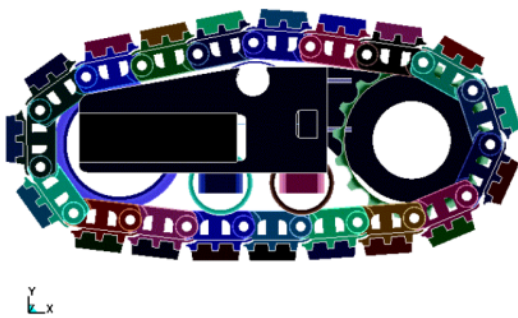

LS-DYNA user input  
Time = 0.2

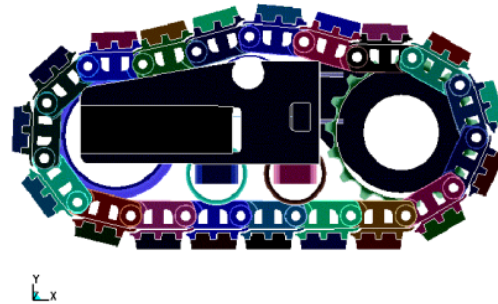
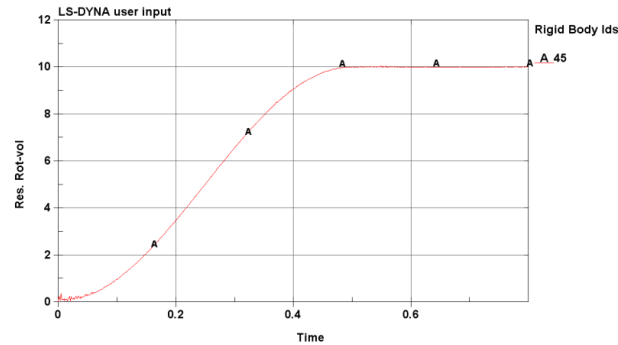
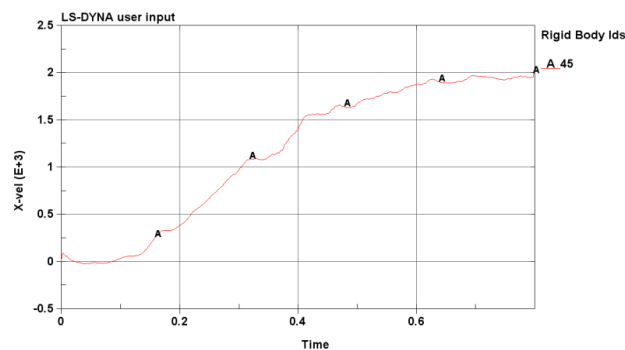

Fig.6: Gravity unloaded and loaded complete system

The next step was dedicated to select an appropriate curve for the velocity of power gear sprocket: the choice has to be a trade-off between the real value and the increased one needed to reduce the analysis CPU time. With a regime velocity of 7.2 km/h, provided by ITM group, the curve velocity in Fig. 7 is the chosen one, while in Fig. 8 is plotted the corresponding forward velocity.



**Fig.7: Power gear sprocket angular velocity (rad/s)**



**Fig.8: Power gear sprocket centre of mass transfer velocity (mm/s)**

Once assessed these initial and boundary conditions, as a typical working application the impact and climbing over a step was chosen. The results coming from the relative analyses will be shown in the next chapter.

During phase 3, the fatigue life of system frame was investigated by using eta/VPG code. Fatigue is a common failure mechanism of various components under cyclic loading. An accurate analysis of fatigue damage requires not only the knowledge of stress/strain history to which the component is subjected, but also a suitable cumulative damage summation technique. The eta/VPG Fatigue Post-Processor analyses and processes LS-DYNA<sup>®</sup> analysis results, predicting the life cycles that the selected system can sustain under a given loading condition. Different approaches exist according to the type of element used to mesh the component to be investigated. The frame was modelled by using solid elements, and for this reason the so-called Stansfield's Approach has to be applied to predict the fatigue life. In Stansfield's algorithm we have:

$$\tau_a = \tau_f - k_1 \sigma_n$$

where:

$$k_I = \frac{\tau_F - \sigma_F/2}{\sigma_F/2} \quad \sigma_F = \sigma_f (2N_f)^b$$

$$\tau_F = \tau_f (2N_f)^{b_0}$$

- $2N_f$  = fatigue life under fully reversed stress (2 reversals = 1 cycle)
- $b_0$  = torsional fatigue strength exponent
- $b$  = bending fatigue strength exponent
- $\sigma_n$  = normal stress on the maximum shear strain plane
- $\varepsilon_f$  = fatigue ductility coefficient
- $\sigma_f$  = fatigue strength coefficient

The torsional fatigue constant cannot be obtained from tests easily and an estimate has to be made:  $\tau_f = 0.54 \sigma_f$  and  $b_0 = b$ .

In the general case, a block of stress history consists of numerous damage events and therefore the corresponding Fatigue Damage  $D$  is obtained by summing the Fatigue Damage  $D_i$  from each individual event. Fatigue Life  $L$  for this block stress history is estimated using Miner's linear damage rule as:

$$L = \frac{1}{D} = \frac{1}{\sum \frac{n_i}{N_i}}$$

where:

- $N_i$  = cycles to failure corresponding to a set of stresses/strains for case  $i$
- $n_i$  = number of stress cycles for test case  $i$
- $D$  = cumulative damage
- $L$  = fatigue life

In this work, the kind of road obstacle impact investigated is just only one and therefore we have a single test case (in the previous formula "i" is equal to 1). Further, in eta/VPG code to take into account an event with a variable stress or strain amplitude fatigue cycling, the Rainflow Counting scheme is used. To compute the fatigue calculation, eta/VPG requires the stress results available in LS-DYNA<sup>®</sup> D3PLOT or ELOUT files.

The test case to be investigated is the climbing over a step (height of 30 mm) with the computation of the frame acceleration and roller forces in the system dynamic response and the following evaluation of the frame fatigue life.

## Numerical Results

In phase 2, the regime velocity was updated to 6.2 km/h to reproduce the real transfer velocity of the undercarriage system. Since the shoe material properties were affected by a small uncertainty, the analyses were performed by applying three different material models, 2 Mooney-Rivlin rubber models with different equation and a rigid material model, as Table 1 points out.

	run 1	run 2	run 3
Shoe Material Type	*MAT_MOONEY-RIVLIN_RUBBER equation 1	*MAT_MOONEY-RIVLIN_RUBBER equation 2	*MAT_RIGID

Table 1: Shoe material models

Fig. 9 shows the climbing over the step (impact time at about 0.32 s), while Fig. 10 e Fig. 11 show a comparison between the different Von Mises stress fields before and during the impact (run 1).

TITAN ITM - MP 1000  
Time = 0.41865

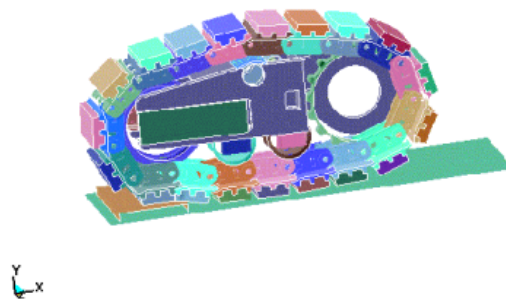

Fig.9: Step climbing over

LS-DYNA user input  
Time = 0.34  
Contours of Effective Stress (v-m)  
max lpt. value  
min=0, at elem# 440713  
max=25.4228, at elem# 436629

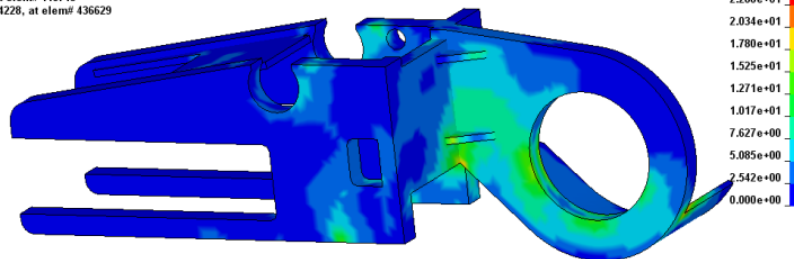

Fig.10: Von Mises stress - transfer phase (max value 25 MPa)

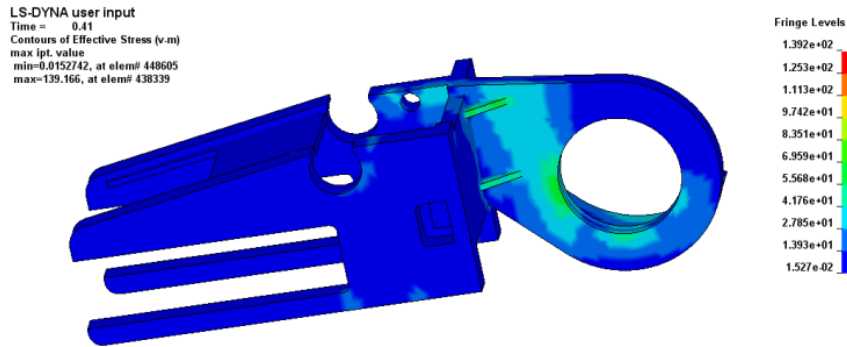

Fig.11: Von Mises stress – impact (max value 140 MPa)

The first investigation has been dedicated to analyze the frame acceleration. Among the three components X, Y and Z, the most relevant is the vertical one, that is along Y. As soon as the undercarriage system impacts the step, the acceleration increases (run 1-2), as it should be. With a \*MAT\_RIGID type (run 3), solution adopted to explore a more restrictive set-up, the undercarriage advancing is affected by the amplified system stiffness, so that the acceleration trend is less smooth.

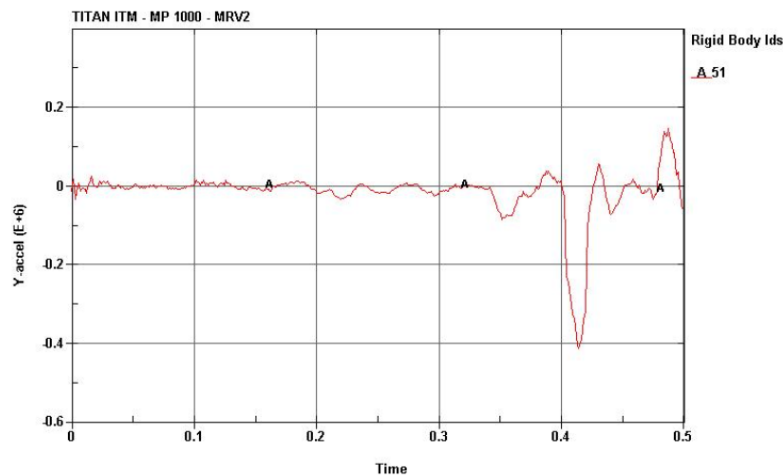

Fig.12: Y acceleration vs. time ( $t_{\text{impact}} = 0.34$  s) - run 2

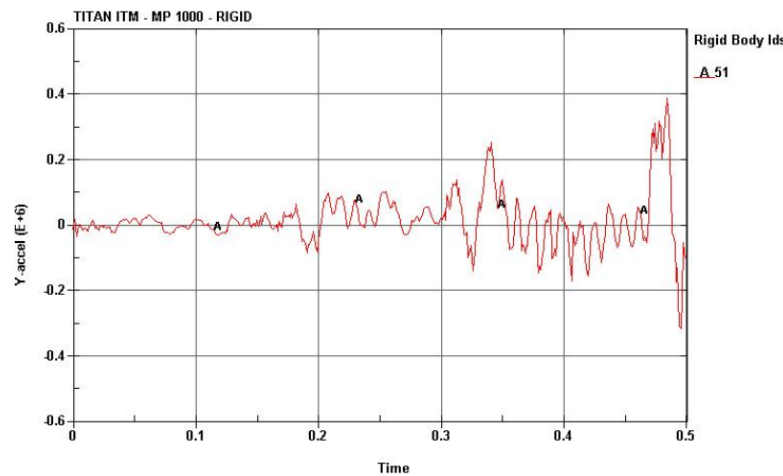

Fig.13: Y acceleration vs. time ( $t_{\text{impact}} = 0.32$  s) - run 3



To understand how the forces distribute within the system and consequently its inner dynamic response, we can study the forces applied into the roller joints. Between the value along Y and the ones along X and Z there is a magnitude order difference of  $10^3$ . Taking as reference the picture in Fig.5, we can compare the Y forces in the three different runs. As the Fig.14-16 highlight, the values of the posterior roller (B JT 475162) are greater than the anterior ones. Further, a stiffer shoe material model (as shown by the run 3 picture – max abs value  $\sim 10^6$  N) implies an increase in the forces magnitude. This cautionary approach guarantees to be confident about the maximum value of the forces affecting the system.

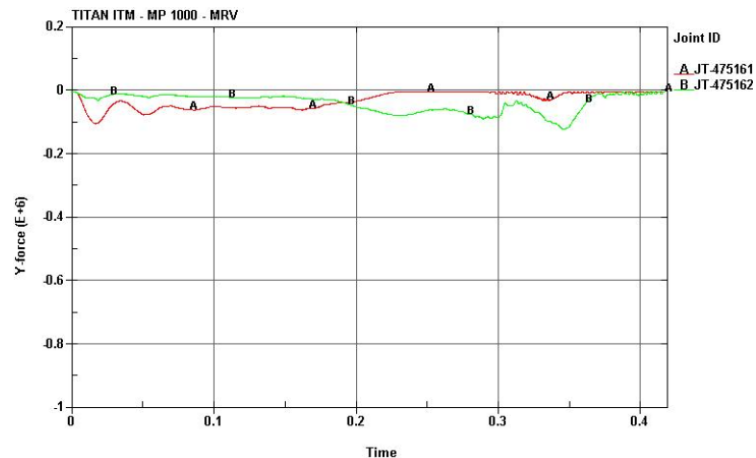

Fig.14: Y force vs. time ( $t_{\text{impact}} = 0.32$  s) - run 1

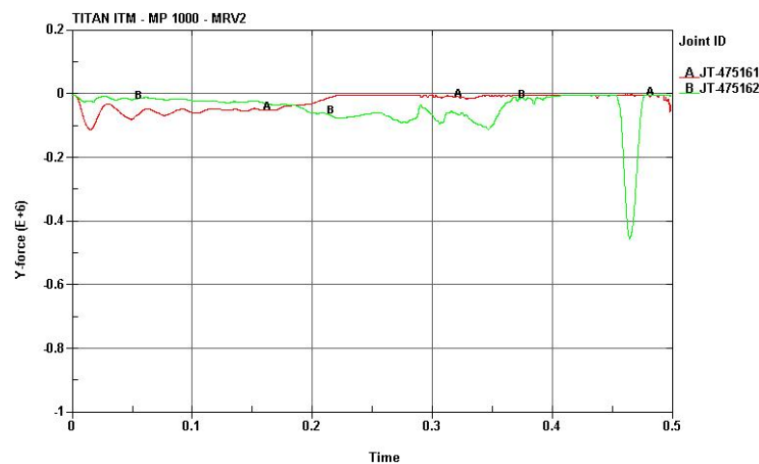

Fig.15: Y force vs. time ( $t_{\text{impact}} = 0.34$  s) - run 2

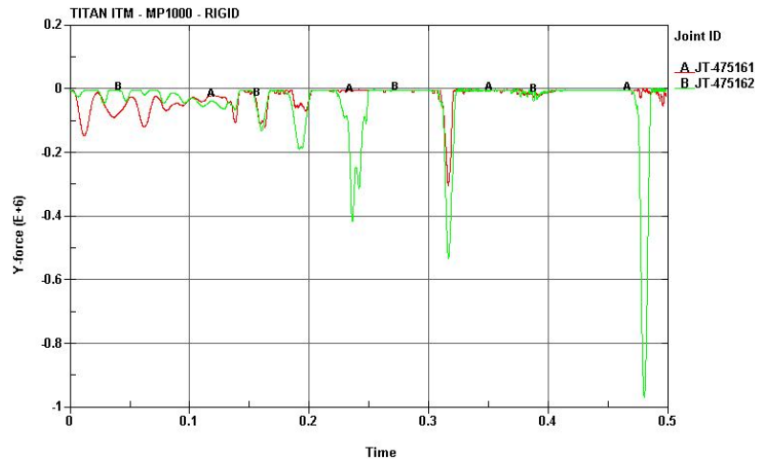

Fig.16: Y force vs. time ( $t_{\text{impact}} = 0.32$  s) - run 3

Starting from the previous analyses, in phase 3 of the activity, the frame fatigue life was investigated. By using the eta/VPG contour plots, fatigue life can be visualized as “cycles to failure” (red = lowest life). The Fig. 17 (run 1) point out the two most critical regions of the frame, while Fig. 18 and Fig. 19 show a more focused area for both frame sides. One area corresponds to the hole connecting the undercarriage system with the remaining part of the machine (zone A), while the second one (zone B) is spread over the inner part of the drive train hole. The minimum fatigue life is equal to  $4.35 \cdot 10^4$  cycles. These results are in good agreement with the ITM Group Engineering Department experiences.

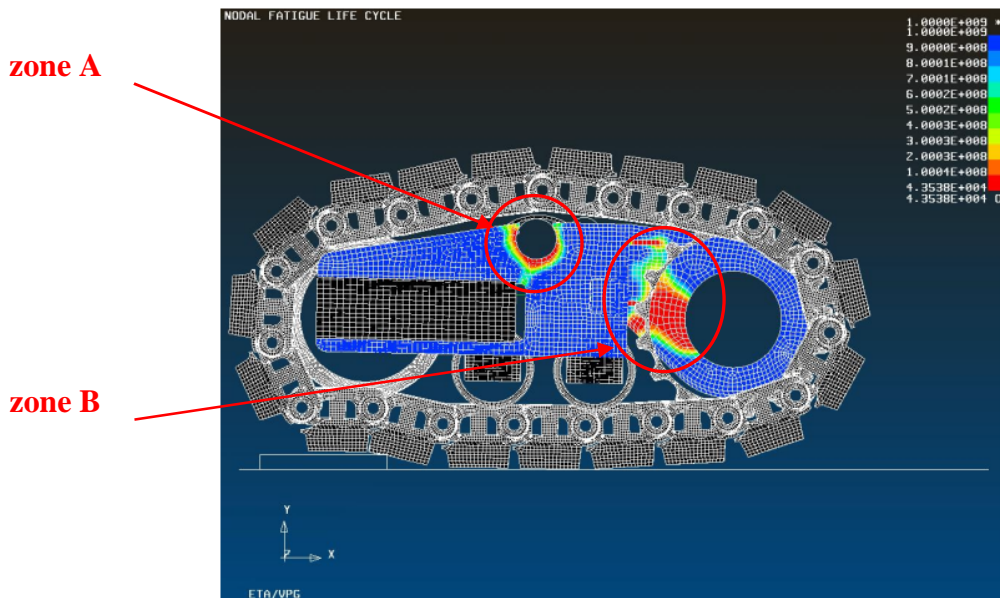

Fig.17: Fatigue life cycles- run 1

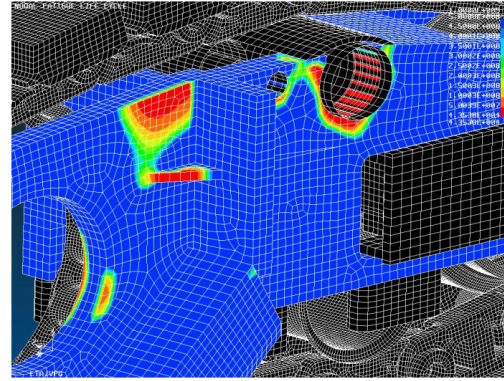
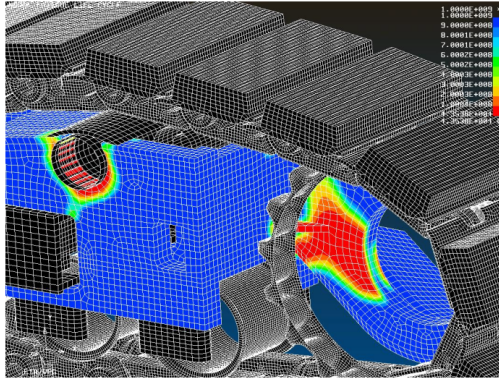

Fig.18: Side 1 fatigue life cycles- run 1

Fig.19: Side 2 fatigue life cycles- run 1

In a similar way, the fatigue performances were computed for the run 3 case. As shown in Fig. 20, the most restraining conditions reduce of a  $10^3$  factor the minimum fatigue life, now equal to  $5.55 \cdot 10^1$  cycles. On the basis of these results, we can assess that the \*MAT\_RIGID hypothesis for the shoe material model is too onerous and restrictive.

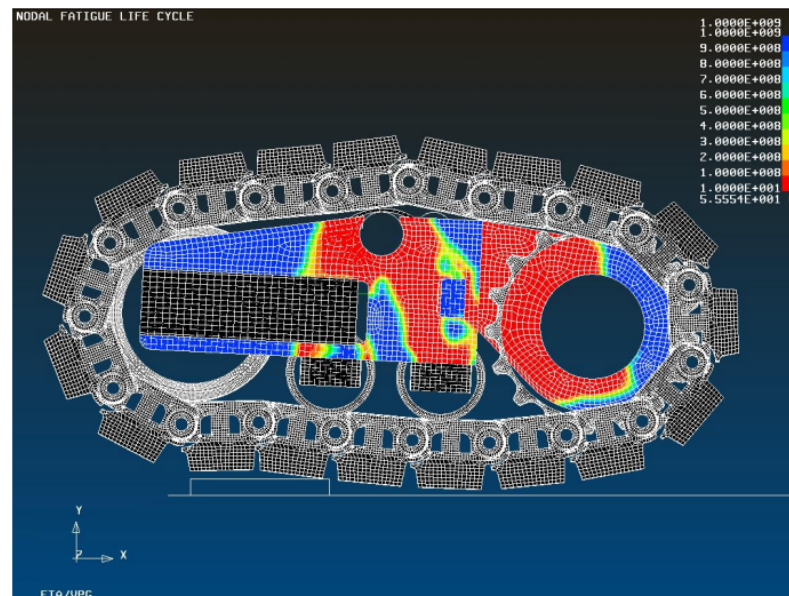
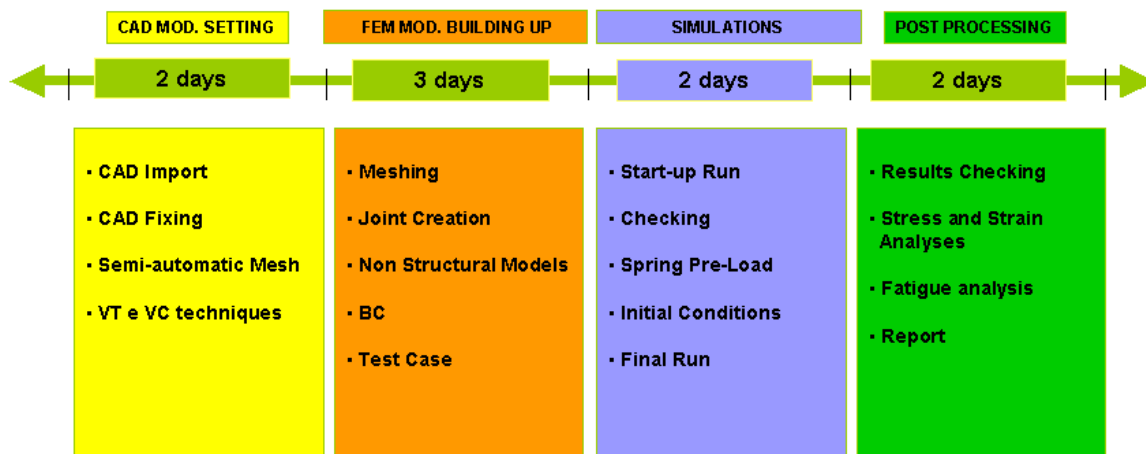

Fig.20: Fatigue life cycles- run 2

In phase 4, the last one, we briefly assessed the feasibility and the effectiveness of the whole process in respect to its implementation into the ITM Group design chain. The following remarks are applicable:

- No severe geometric complexity of the components → FEM models building is practicable
- Complete model can be easily build up in Ansys/WB environment
- Phenomenon to reproduce is non linear dynamic
- Boundary and initial conditions can be easily applied in eta/VPG environment

An evaluation of time required to perform the whole activity is described by the diagram in Fig.21.



**Fig.21: Process integration into ITM design chain**

## Conclusions and Discussions

A focused new design procedure has been implemented by using Ansys/WB, eta/VPG and LS-DYNA<sup>®</sup>. It is able to predict accurately structural responses of a track chain undercarriage system, starting from 3D parametrical CAD models, using LS-DYNA dynamic simulations and adopting eta/VPG to predict minimum fatigue life under the working conditions.

The developed procedure and methodology can be easily integrated into the ITM Group design chain in order either to maximize the time efficiency of structural design development flow or to reach best performance for complete undercarriage systems.

Numerical results are in good agreement with the ITM Group Engineering Department experimental experiences.