

LS-DYNA[®] Durability Load Cases: An Automated Template Driven Process Using the ANSA Task Manager

Yianni Kolokythas¹, Dietmar Fels², Matthias Weinert²

¹BETA CAE Systems SA, Thessaloniki, Greece

Ford-Werke GmbH, Cologne, Germany

Abstract

Process organization and standardization are essential in a CAE turnaround cycle. In an era, where the vehicle development time is getting reduced and the number of load case analysis is getting increased, the need for automatic standard processes is increasing.

Ford-Werke GmbH and BETA CAE Systems SA are cooperating to develop streamlined, automatic processes, using the ANSA Task Manager. The goal, of these template driven processes, are to create realistic, repeatable and robust durability simulation models.

The ANSA Task Manager supervises the generation of the simulation models, while ANSA Data Management, in the background, facilitates the components management, ensuring that the engineering teams will always work with the most up-to-date data. The simulation model set-up becomes a repeatable and user-independent procedure, safeguarding the model quality and fidelity.

Introduction

Definition of a Loadcase

A load case build-up process is a series of modeling actions in order to model an engineering testing protocol or a loading condition. This process requires input data and the modeling steps that will create the desired output data.



Figure 1. Graphical definition of a load case

The input data can be raw geometry parts or it can be completed sub models (sub assemblies). The output data can be a single solver deck output file or an output composed of several includes files.

The modeling steps are all the actions that are needed to prepare the output. Such actions are the applications of joints, contacts, boundary conditions, positioning of dummies and test devices, control keywords etc.

Difficulties in Building a Load Case

This process as easy as it is to define is a very complex and error prone process to materialize. This is because:

- It is a process that greatly depends on the engineer's technical expertise.
- It is difficult to gather all the data needed for the load case.
- It needs to follow written guidelines.
- It is difficult to control minor parameter changes.
- It is difficult to repeat it.
- It is not a streamlined operation.

Ford-Werke, in cooperation with BETA CAE Systems SA, has proceeded in developing a template driven durability process to address the above issues. BETA CAE Systems SA using the technologies of the Task Manager has delivered multiple load case templates for various loading conditions. The Task Manager templates have been delivered and they currently are in testing phase, before they enter production work.

Some of the tasks that were developed as part of the project are:

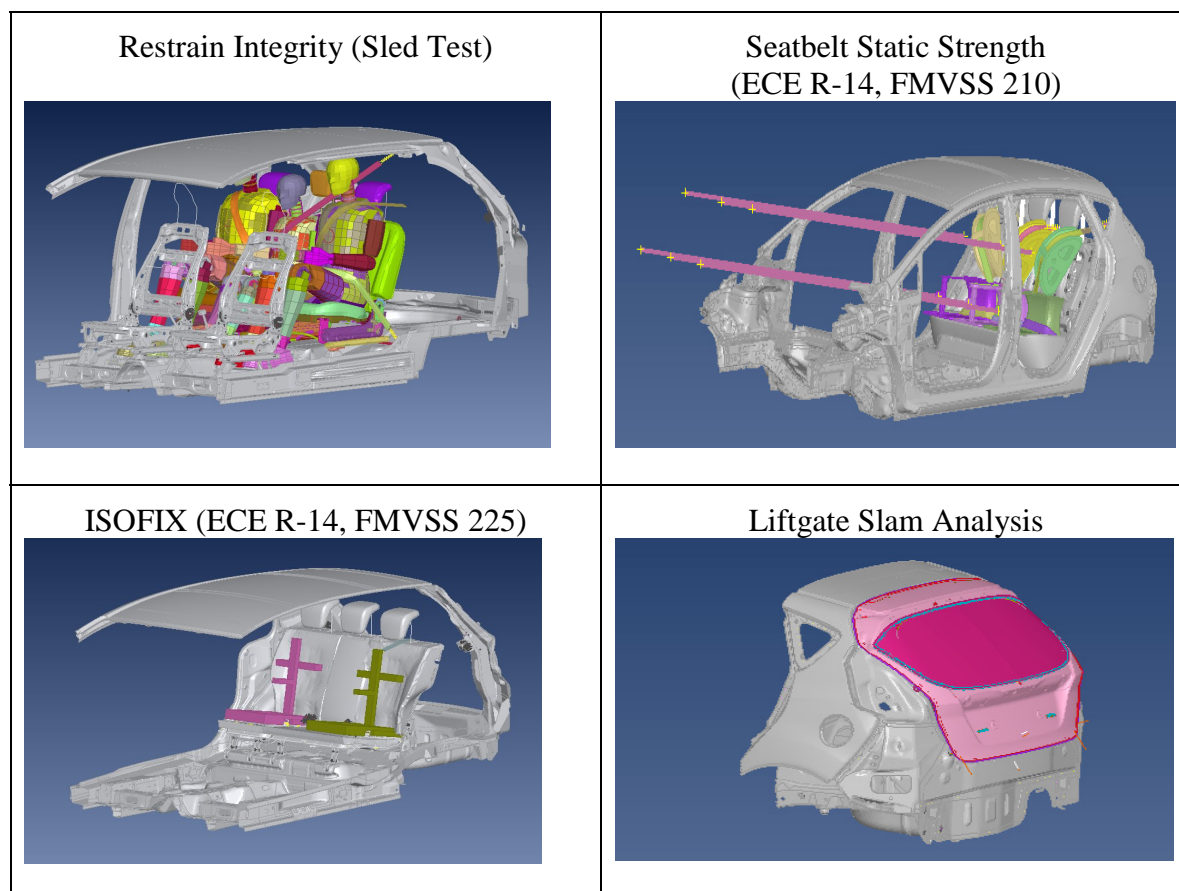

Figure 2. Some of the load case developed to Task Manger Templates

The ANSA Task Manager

Task Manager Definition

The ANSA Task Manager is a tool within ANSA that allows the creation and execution of template driven processes. A Task is a hierarchical process comprising a series of distinct modelling actions that have to be followed in order to set-up a discipline specific model.

Essentially as shown in image below the Task Manager replaces the manual modelling steps with automated actions (Tasks).

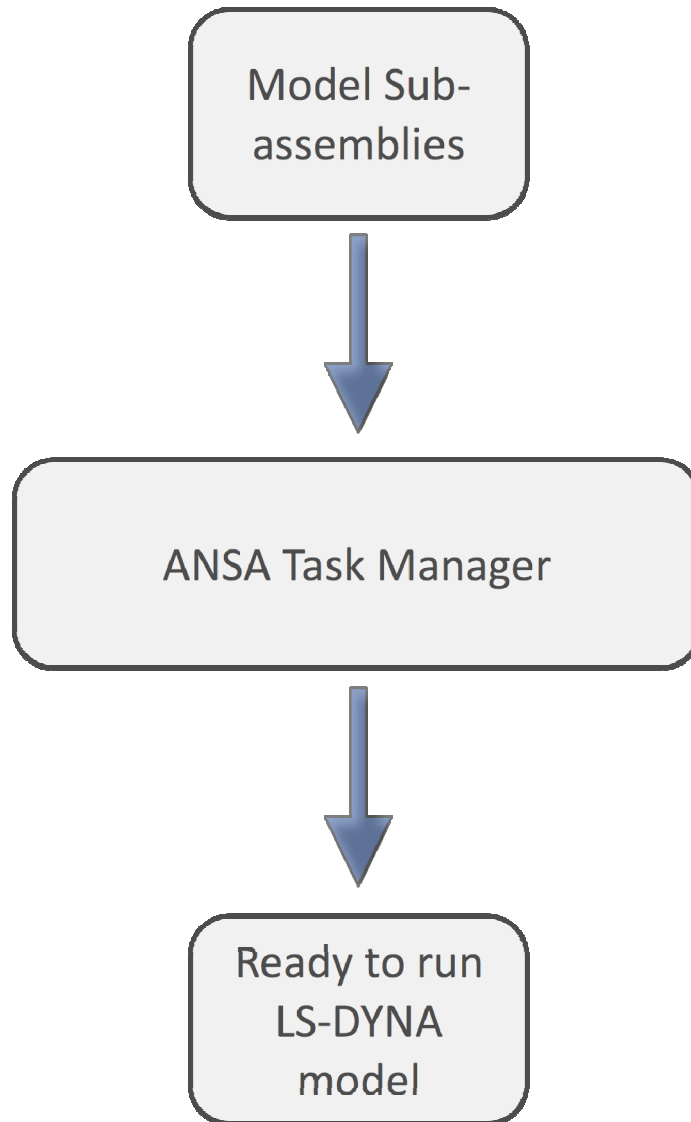

Figure 3. Graphical definition of the Task Manager. The Task Manager has replaced the manual modeling steps.

The Task Manager is divided into two major categories. These are the model assembly and the load case build-up. In addition to modeling actions the Task Manager's goal is to carry all the pre-determined parameters such as Connector and Boundary Condition properties, seatbelt materials and properties, Dummy Positions etc.

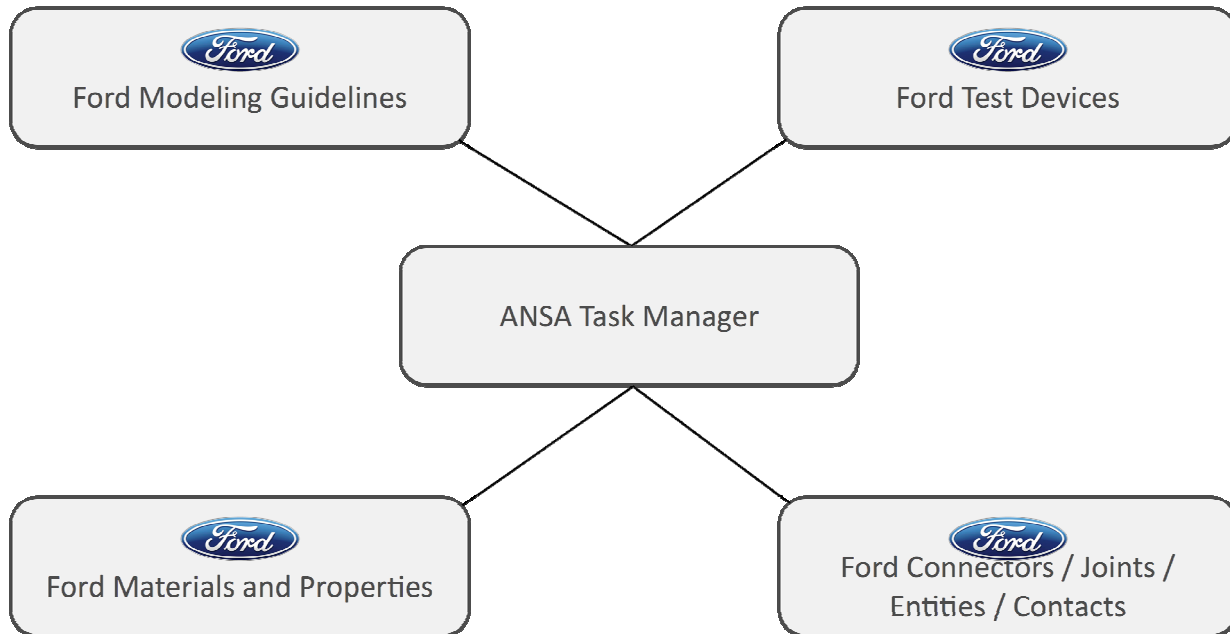

Figure 4. Information contained in the Task Manager and ANSA Data Manager

The ANSA Data Manager

In order for the Task Manager to be able to retrieve all the required information it needs to cooperate with another ANSA tool called ANSA Data Manager. The ANSA DM is a structured and centralized data management system. It assures that all engineering data, which is used for the creation of the model, is stored securely and is organized in a way that can be easily retrieved by all CAE engineers working on various CAE disciplines.

A task should be built by the CAE expert and saved in the ANSA DM, thus making it available for usage by the whole CAE team.

Model Assembly

The Model Assembly part of the Task Manager is where the assembly Tasks take place. Such Tasks are the sub model merging, application of connections and connectors etc.

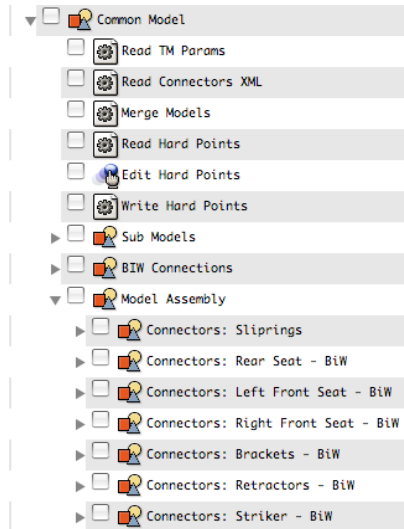

Figure 5. The Model Assembly group of Tasks

Model Merging

The model assembly is achieved with the assistance of the Task Manager. The sub-models of the load case (BiW, Seats, etc.) are read into ANSA. These sub-models are already meshed and all their internal connections, joints and contacts are already applied.

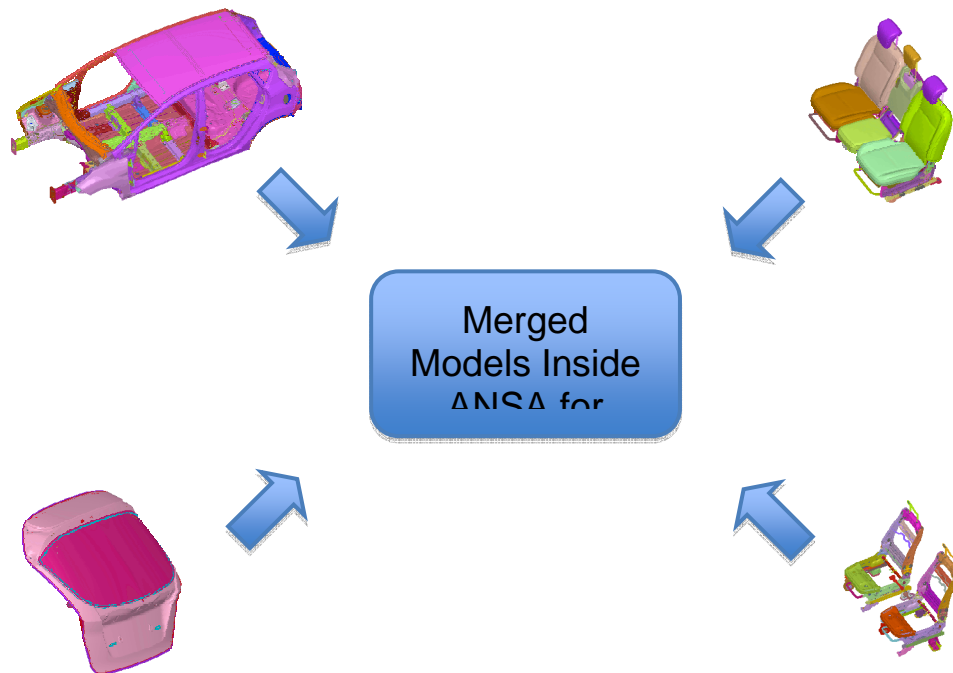
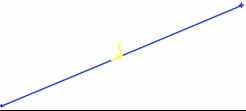

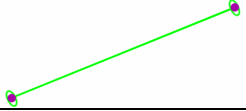

Figure 6. Merging of all sub-models into ANSA

Connecting the Model

A major task is the connection of the sub assemblies. These connections are realized with the ANSA entities called Connectors. The Connector Entities are applied during the execution of the Model assembly group of items. Some characteristic features of the connector entities' realization are:

- The Connector Entities are defined using mesh density independent patterns for the identification of the connected entities. Thus, a connector can be applied on a hole, circular feature or a certain number of nodes or elements, in a pre-defined search domain.
- Connector Entities that connect a rigid with a deformable component with rigid interface automatically detect the case and create *CONSTRAINED_EXTRA_NODE instead of *CONSTRAINED_NODAL_RIGID_BODY entities.
- Connector Entities that connect rigid components together with rigid interface, automatically detect the case and create *CONSTRAINED_RIGID_BODY entities.
- The Connector Entities can use the built-in representations (i.e. revolute and spherical joints) or custom made ones, retrieved as templates from ANSA DM libraries. LS DYNA deck card values of the library items can also be parameterized so that they can be editable during the set-up of the connector.

Template in ANSA DM	Description
	*ELEMENT_BEAM_ELFORM_1 Parameters: diameter, length and orientation according to application
	*CONSTRAINED_JOINT_SPHERICAL Parameters: Value of added mass on both ends
	*CONSTRAINED_JOINT_REVOLUTE Parameters: Value of added mass on both ends, orientation according to application
<i>Table 1. Parameterized templates for connectors retrieved from the ANSA DM library</i>	

The figure below shows an example of a connector entity realization.

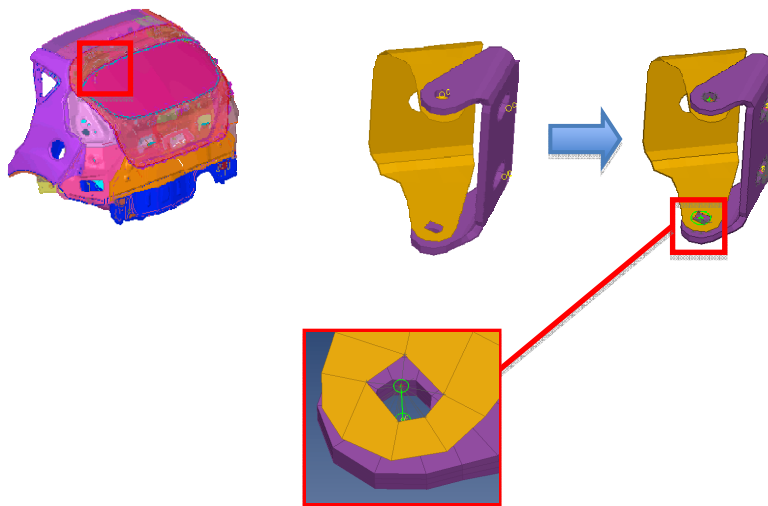

Figure 7. The liftgate hinges connectors are applied and revolute joints are created.

Managing the Connector Information

The Connector locations and properties could change from one Task into the other. In addition, the number of connectors may change, based on the design changes of the sub assemblies. As an example, a seat in one model may connect to the BiW in four locations and in another model a seat may connect to six locations.

Many of the load cases (such as the Seatbelt restrain integrity, Belt Static Strength, ISOFIX etc.) share the same connector information. To avoid multiple users to have to do the same work of setting up essentially the same connectors, a procedure was developed to output and share this information through XML files. One user sets up the new locations and properties of the existing Connectors and adds new connectors when needed. The information is shared through an XML file, with the rest of the team. It can either be used in the same load case or in a different type of a load case that has the same connectors/ connector locations.

Dummies and Test Blocks Positioning

The durability load cases presented in this paper require demanding positioning functionality in order to position the dummies and the test blocks.

Handling the Dummies

The hardcoded functionality of dummy positioning is used to read and position the dummy. The dummies are read from the DM and the tasks guide the user to rotate and translate the dummy to the correct position. While the dummy is in the correct position, the position can be recorded. This recorded position can be saved in the task and anytime the task is re-executed the user selects from the list of the available saved positions. This capability reduces the amount of work and makes the task repeatable, since it would be very difficult otherwise to position the dummy with the exact same rotations and translations the second time around.

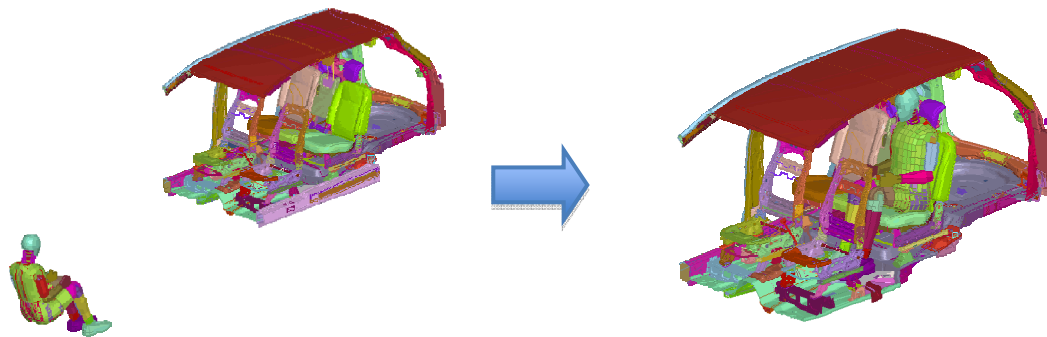

Figure 8. Dummy Positioning in Restrain Integrity Loadcase

Handling the Test Blocks

The positioning of the test block is a complex procedure where special tools were developed with ANSA's scripting language. Due to the fact that there are no pre-defined start and end points for where the blocks need to be positioned, a procedure was set-up where the user does some manual work with the assistance of the Task.

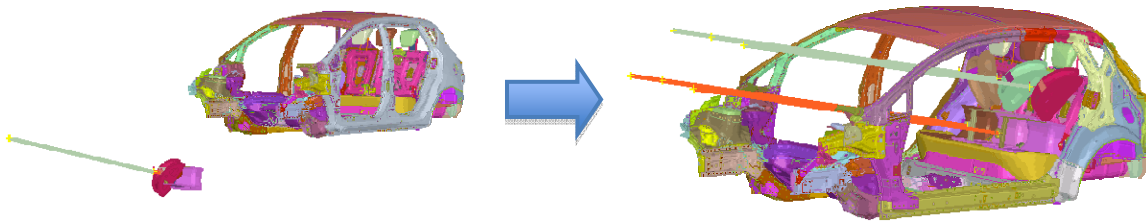

Figure 9. Initial and final state of the blocks in the ECE-14 loadcase.

The figure above shows the case of the ECE-14/FMVSS 210 where one upper and one lower block are read in. With the assistance of script functions the blocks are positioned and the additional two pairs are created automatically. In the case of middle blocks, an option to edit their position is given due to the higher H-Point of the middle passenger. All the positioning steps are saved in a session file. This gives the user the ability to position the blocks automatically the second time the task needs to be executed when there is a design change in one of the sub assemblies. Similar procedure was developed for the ISOFIX test block positioning.

Building the Load Case

The Assembly Tasks are followed by the Load Case creation Tasks. The roles of these Tasks are to create loading and boundary conditions of the load case. Such items include the cutting of the model, the creation of contacts, creation of SPCs and prescribed motions etc.

The most important aspects of the Load Case Task are outlined below.

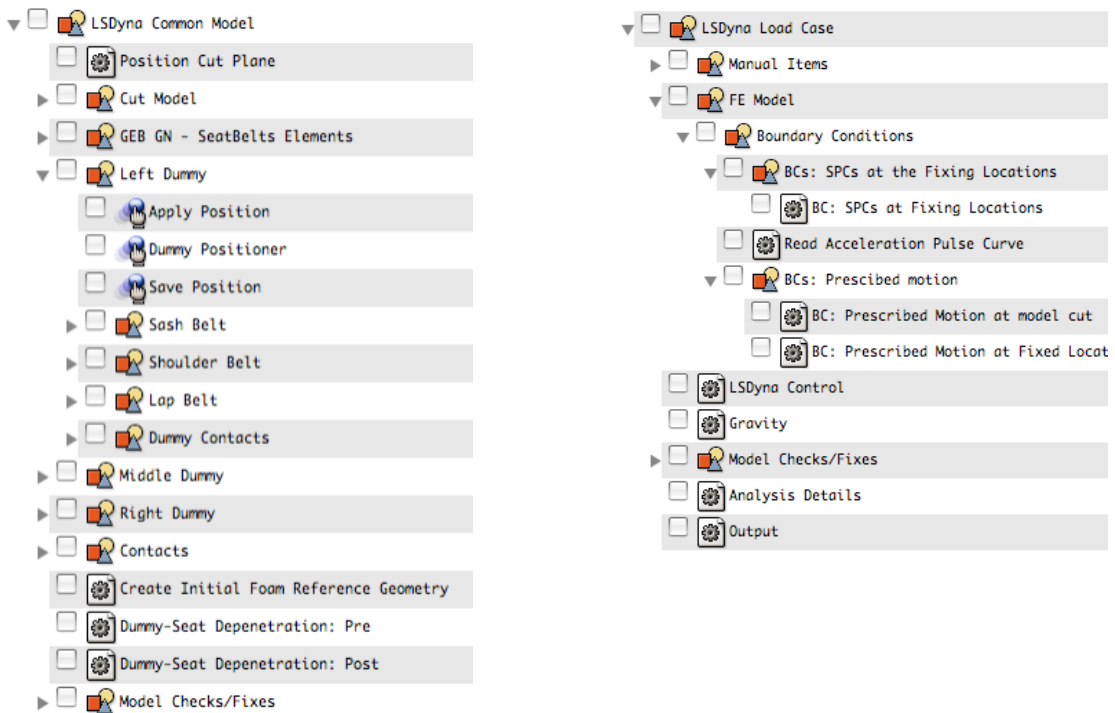

Figure 10. The load case related group of tasks.

Cutting the Model

The Cutting Plane reduces the size of the model and only the needed portion of the model is kept. On the free edges of the result of the cutting plane, SPCs and prescribed motions are applied, depending on the need of the specific load case. The cut plane is predefined in the Task and the CAE expert can predefine its cutting position.

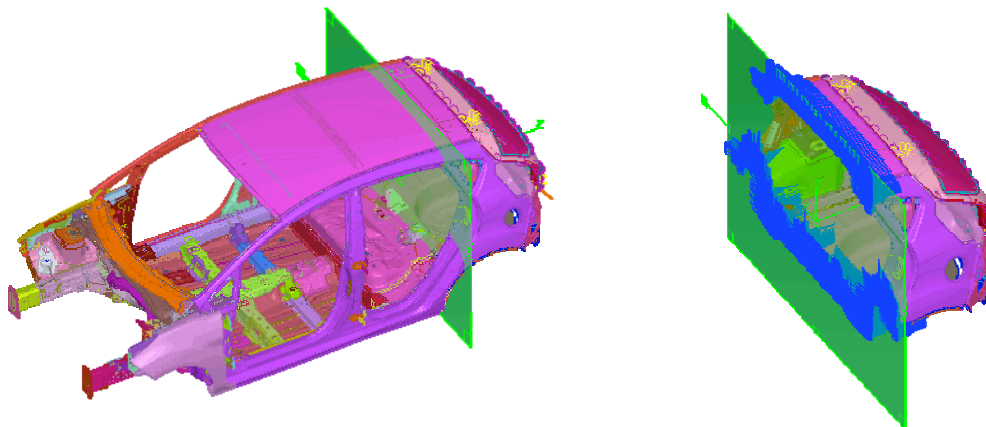

Figure 11. Plane cutting with creation of SPCs on the boundaries

Creation of New Entities, SPCs and Loadings

During the creation of a load case there is a need to create new entities. These new entities are created using the GEB (General Entity Builders) group of entities. These entities work similarly to the connectors. These entities can be retrieved from the ANSA DM with their properties parameterized and with GEBs they can be applied in the needed location and orientation.

Template in ANSA DM	Description
	*ELEMENT_SEATBELT_SLIPRING / *ELEMENT_BEAM_ELFORM_2 Parameters: beam inertias and cross sectional area, slipring dynamic friction coefficient Load Case: All load cases that require seatbelts
	*ELEMENT_SEATBELT_RETRACTOR / *ELEMENT_SEATBELT_SENSOR / *ELEMENT_BEAM_ELFORM_2 Parameters: Sensor trigger time, beam cross sectional area and inertias Load Case: All load cases that require seatbelts

Table 2. Parameterized templates for GEBs retrieved from the ANSA DM library

The GEBs are also used to apply boundary conditions such as SPCs, loadings and velocities. The entities, again, can be either retrieved from the ANSA DM or they can be options of the GEB card itself. Such boundary conditions (used by GEBs) that are saved in the DM are the *INITIAL_VELOCITY_GENERATION and *BOUNDARY_PRESCRIBED_MOTION.

Model Checks

The model is checked prior to the output with respect to load case specific entities definition. There are multiple checks that can be performed for the various aspects of the model.

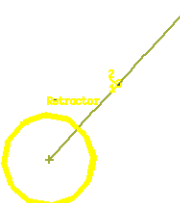
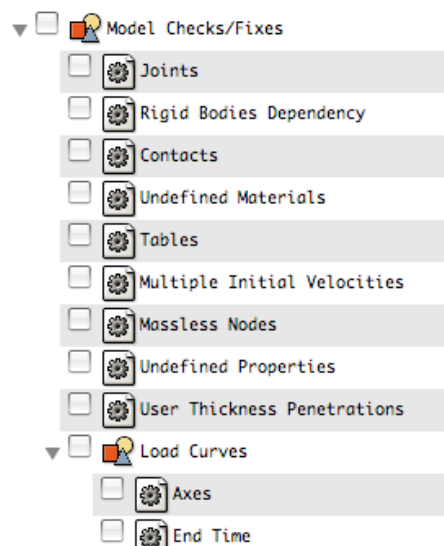

Figure 12. Various checks that are performed before model output.

Other Various Tasks

Solver Controls: The Solver Controls are set-up once for each load case by the CAE analysis expert and are safeguarded in the Task.

Contact Interface Cards: The contact interface cards, along with their parameters, are set-up once during the Task build-up. During the Task execution, Task Manager automatically fills the contact sets and there is no need for user-intervention in the contact definition.

The Role of Scripting

The role of scripting is to supplement the hardcoded ANSA Task Manager functionality, for functions that are very specific and specialized to a load case. Such cases where scripting has heavily been used is the positioning of test blocks, previously stated and in tasks where calculation is needed to be made. An example is the calculation of the angular velocity of the lift-gate slam load case.

Another example of specialized tools that were built using ANSA's scripting language is a tool that does dummy-seat de-penetration using the LS-DYNA solver. When a dummy is positioned at the H-Point, there is an initial penetration of the dummy with the cushions of the seat. Ford's procedures require that this de-penetration should be performed through the solver. A DYNA output is created without destroying the working model. This output file is solved in DYNA, and afterwards, the task with the assistance of μ ETA, read the new (deformed) coordinates of the cushion nodes.

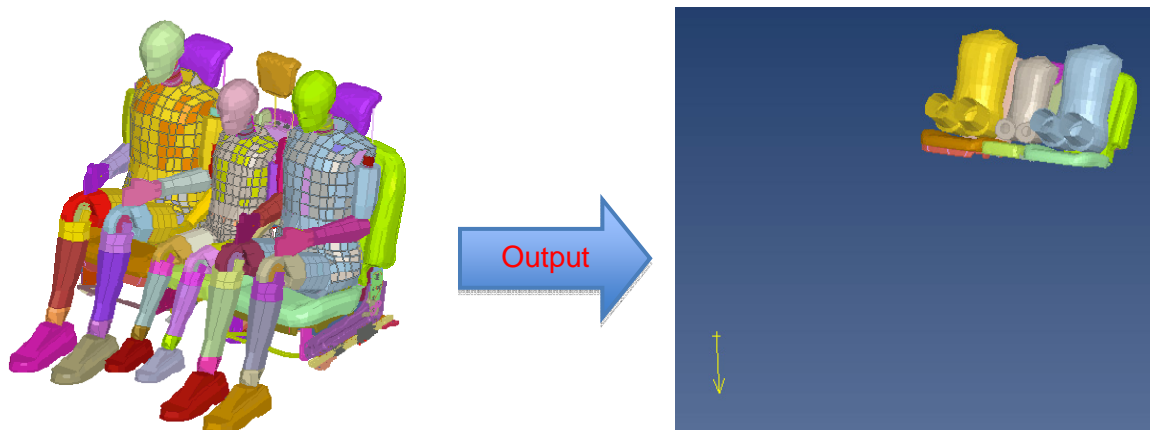

Figure 12. A dummy de-penetration LS-DYNA input file is created from the main file.

Conclusions

The data organization and process standardization are necessary for the load cases' creation in Ford-Werke. This can be achieved with the use of ANSA Task Manager in combination with ANSA Data Management. With the aid of ANSA Task Manager, Ford can safeguard the model quality and promote knowledge transfer, capturing the best-proven practices for the analysis model build-up as a sequence of modeling actions. ANSA Data Management assures the organization of all data, storing them in a structured form under a common location, enabling their easy retrieval by the Task Manager.

During the execution of pre-defined Tasks, ANSA Task Manager makes sure that all task items are properly executed, considering at the same time, possible dependencies between them. The validity of model entities definitions is checked prior to the output with the aid of various built-in check algorithms. The model quality is safeguarded and the build-up of durability simulation models becomes fast and efficient.

Summarizing, the effort of creating a template process has the following advantages:

1. Changes in analysis parameters are easily applied, while modifications of crucial areas / components are seamlessly imported.
2. The process becomes repeatable and robust: Actions needed to build a model are followed in sequence, considering their inter-dependencies.
3. The template process aims to reduce the overall CAE turnaround time.
4. Association with ANSA DM assists data collection and organization and promotes the use of library items.
5. Model quality becomes inherent in the process and does not depend on user experience/expertise.

References

1. ANSA version 13.0.1 User's Guide, BETA CAE Systems S.A., July 2009
2. Makropoulou I., Kolokythas Y., Rorris L., "LS-DYNA Impact Model Build Up: Process Automation with ANSA Data Manager and Task Manager", 10th International LS-DYNA[®] User's Conference, Detroit, USA, June 2008
3. Seitani s., Giannakidis M., "Definition and Parameterization of a Task Manager Process Workflow, Applied on the Generation of an ABAQUS Loadcase", 2nd International ANSA and μETA Congress, Halkidiki, Greece, 2007
4. LS-DYNA Keywords User's Manual. Version 971 R4, Livermore Software Technology Corporation, Livermore, 2009.