

Systems Engineering Approach in Development of Delphi Driver Protection Module (DDPM) by Virtual Engineering

Mohamed Sahul Hamid
Minoo J. Shah
Jason R. Ridgway
Richard K. Riefe
Delphi Corporation, Troy, MI

Abstract

In this paper, the design and development of the Delphi Driver Protection Module (DDPM) using a systems and virtual engineering approach is presented. LS-DYNA software tool was used in virtual prototype studies. The DDPM consists of driver side energy absorbing components. The components included in this module are 1) an adaptive Energy Absorbing (EA) steering column, 2) driver air bag, 3) steering wheel, 4) energy absorbing knee bolster, and 5) adjustable pedals. Each individual component was designed virtually and the virtual design was validated with limited test results. Further, a sub-system mini-sled model using a Blak Tuffy dynamic test was developed to study the functioning of the module due to upper torso loading during a crash. The results of this mini sled model were correlated with actual physical tests. For system level response study, a full finite element sled model was developed. The results of these studies using virtual engineering approach are presented.

Introduction

The modularization of automotive structures such as the door module, front end module, cockpit module, etc., are becoming common in automotive industry in order to minimize the production cost, reduce the development time and enhance performance of crashworthiness and occupant protection. These structures have to meet various government safety requirements as well as manufacturer's internal requirements. Also, the safety star rating system for various crash conditions such as US NCAP, EURO NCAP, etc., is becoming a norm of the performance index and hence provides a commercial advantage to vehicle manufacturers. A virtual build of the vehicles based on mathematical analytical tool is replacing the more costly and time consuming hardware build and testing during development cycle. The virtual prototyping process optimizes the design using simulation software tools before the prototype build.

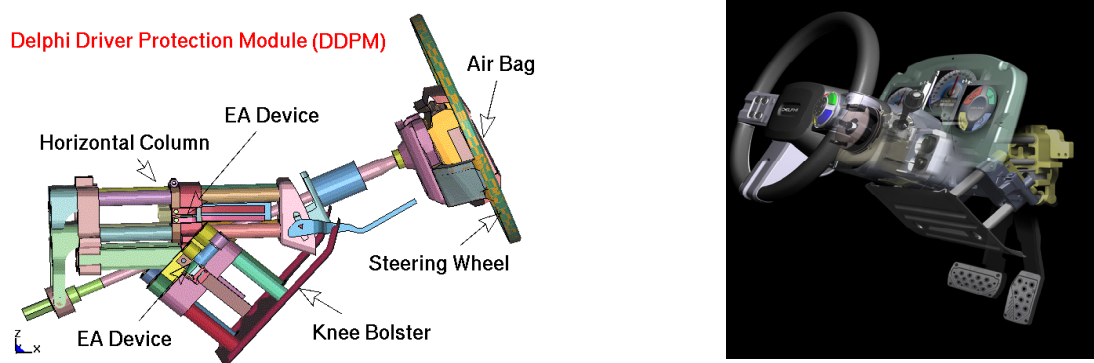

Figure 1. DDPM

In an event of a frontal collision or crash, the occupants of the vehicle are to be protected from serious injuries. Normally, the protective schemes include an advanced vehicle crumple zone, energy absorbing instrumental panel, knee bolster, steering columns and supplemental restraint

system such as airbags. The major driver side protective components are 1. An Energy Absorbing (EA) steering column and steering wheel, 2. A driver side air bag and 3. An energy absorbing knee bolster. The DDPM is an advanced safety system module that integrates the major components of the driver frontal system such as knee bolster, steering column, steering wheel and the driver air bag without the seat belts as shown in figure 1. . In addition to the energy absorbing components, the DDPM also includes brake pedal which will be moved forward during a crash event. The designs of the individual components are based on specific vehicle architecture and the performance requirements would vary widely. This paper will cover the process and methodology for understanding requirements, developing designs to meet those requirements, virtual testing for validating those designs using LS-DYNA and validation with limited physical tests.

Systems Engineering Process

The following Systems Engineering V-Diagram (Fig. 2) shows how all systems engineering steps are normally used in vehicle development program.

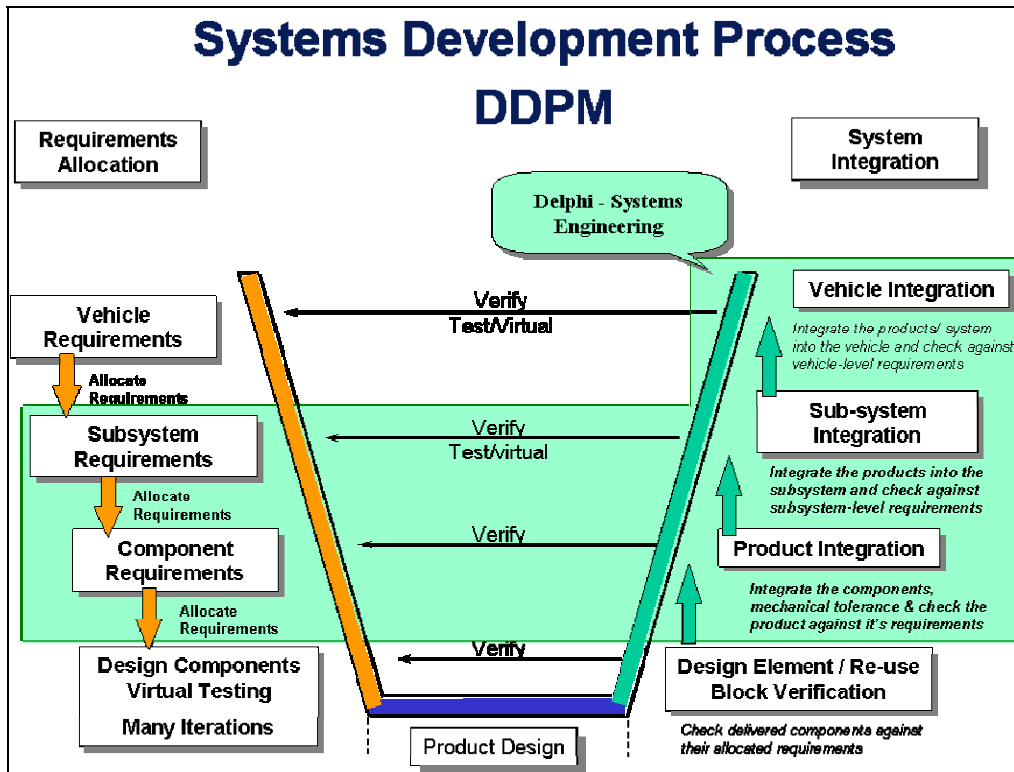

Figure 2. Systems Engineering V-Diagram.

The OEMs are required to meet many mandatory government safety regulations in full vehicle system level. These regulations are stipulated under Federal Motor Vehicle Safety Standards (FMVSS) by the government transportation agencies. These regulations cover all types of vehicle crashes; frontal impacts, side impact, pole impact, roll over etc. In addition to Government requirements, the OEMs have their own additional compliance requirements.

Frontal impact occupant protection regulation is covered by FMVSS208 [Ref. 1]. Typical vehicle level requirements are summarized in the following table.

Injury Criter.	HIC 15ms	Neck Injury Nij	Fz Crit. Tension (N)	Fz Crit. Comp. (N)	My Flex. N-m	My Exten (N-m)	Chest Accln. (g's)	Chest Defl. (mm)	Femur Load (kN)
HYB. III 50 th %ile	700	1.0	4500	4500	310	125	60	63	10
HYB. III 5 th %ile	700	1.0	3370	3370	155	62	60	52	5.8

Table 1. FMVSS 208 Vehicle level requirements.

Sub-system level requirements are provided to verify the functioning of the components assembly. Typically a mini-sled model such as FMVSS 203 [2] is used to evaluate the steering column dynamic performance. The component performance requirement will widely vary depending upon the architecture of the full vehicle. In general, the individual component specifications may be following and may vary from OEM to OEM based on vehicle architecture.

1. KNEE BOLSTER (*Femur Load*)

1. For a 5th %ile occupant, the load is less than 6.8 kN per knee.
2. For a 50th %ile occupant, the load is less than 10kN per knee.

2. STEERING WHEEL

1. The wheel should not crack due to 60mm deflection at 6 and 12 O'clock positions.
2. The wheel frequency should be greater than 50 Hz.

3. STEERING COLUMN

Column Stroke:

1. Column should stroke and not bind during frontal crash.
2. Column motion in a 30 mph zero degree frontal unbelted crash does not exceed 100mm in the horizontal direction

Column Force

The column force is with in the range 2kN – 8kN.

Column NVH frequency

The column frequency should be > 36Hz.

There may be many more requirements in addition to above mentioned items. The driver side air bag will have many requirements and are not covered in this paper.

Component Design and Validation

The design of each of the above mentioned components are described briefly. The virtual prototyping and physical test validation are also given.

Knee Bolster

A typical knee bolster is shown figure 3. It comprises of energy absorbing device for each knee.

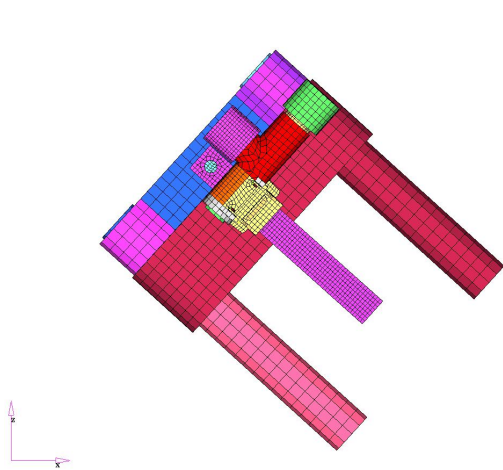

Figure 3. Knee Bolster

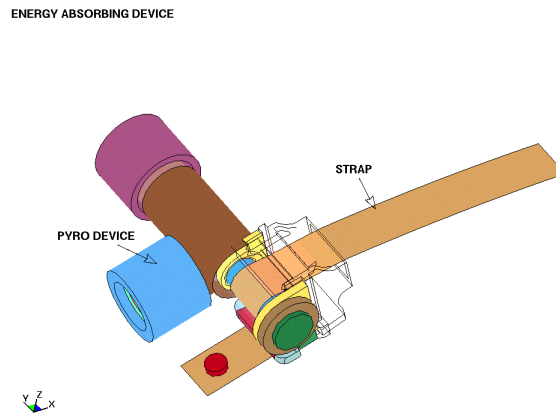

Figure 4. EA Device

The design and analysis of the EA device are documented in previous publication [3]. Various strap shapes were designed to meet the knee bolster requirements given in the table 1.

Steering Wheel System

The steering wheel deformation during crash is critical since its performance influences the injury number such as chest deflection. A typical steering wheel system is shown in figure 5. The static deflection analysis using LS-DYNA explicit option and the test result correlation are shown in figure 6 for 6 O'clock loading conditions. The performances of various 3D element types in LS-DYNA were also investigated.

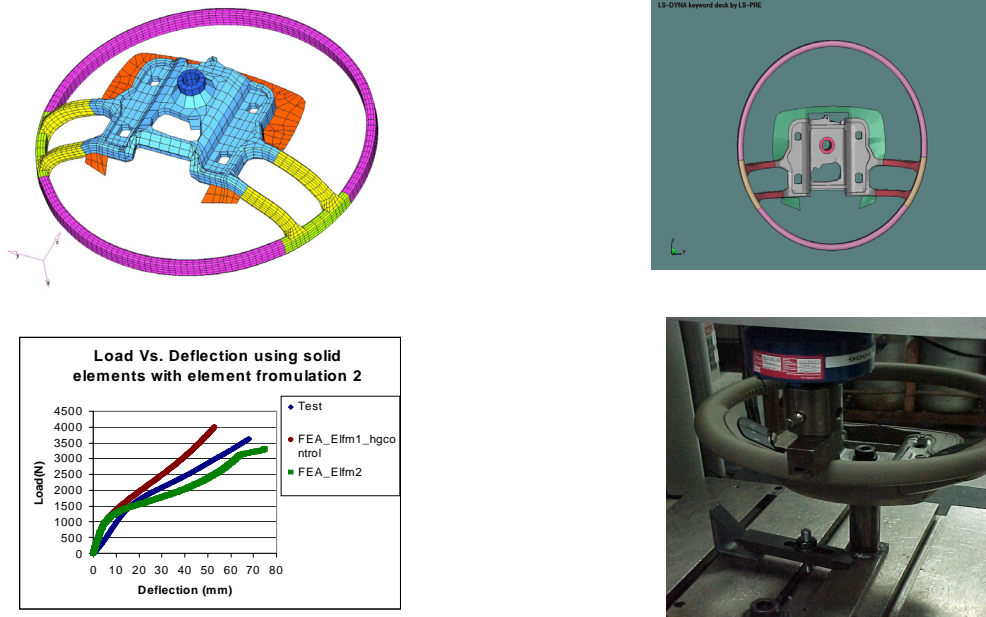

Figure 6. Steering Model and Analysis

The NVH analysis of the wheel is also performed using LS-DYNA implicit option. The natural frequencies and corresponding mode shapes are shown in figure 7. For this particular wheel design, the natural frequency was well above lower minimum requirement.

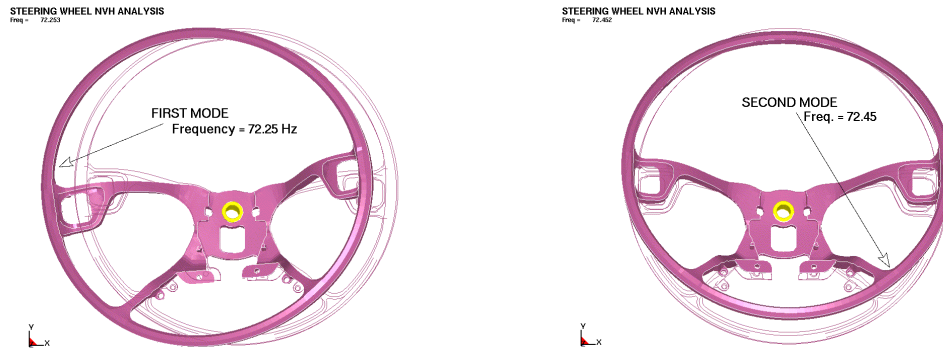

Figure 7. Steering Wheel Vibration and Mode Shapes

Steering Column

The steering column is shown in figure 8. This model included all the details of the column components such as bearings, translational joints, etc.

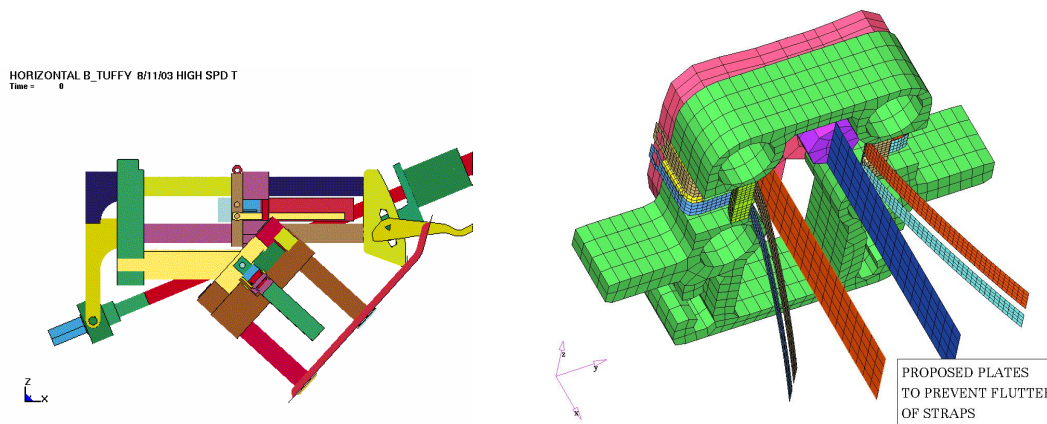

Figure 8. Steering Column

The initial CAE analysis showed that the column was binding and the design of the bearing were updated to eliminate the column binding.

Figure 9. Design Modification

During the column stroke, the straps were fluttering. Additional plates were attached to the column assembly as shown in Fig. 9 to eliminate the flutter.

Sub-System Evaluation

A sub-system dynamic model using Blak Tuffly (Body Block) was developed to study the performance of the column assembly due to dynamic impact load. The sub-system model is shown Fig. 10.

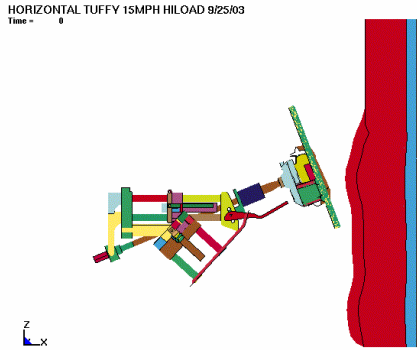

Figure 10. Sub-system Model

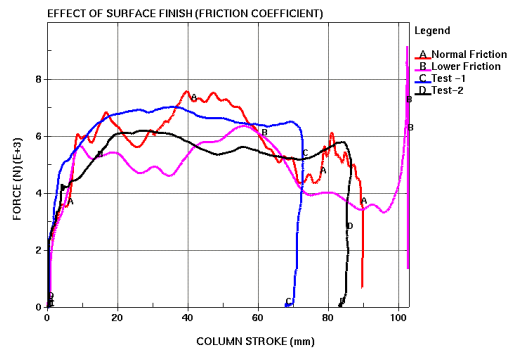

Figure 11. Force vs Column Stroke Plots

The body block was impacted with 15 mph. Many iterative simulations were conducted to evaluate the effect of surface finish (friction coefficient), sensitivity of the body block position, etc. The force vs column stroke results are shown in Fig. 11. Here, the effects of the surface finish of the bearing on column stroke verse force developed are shown.

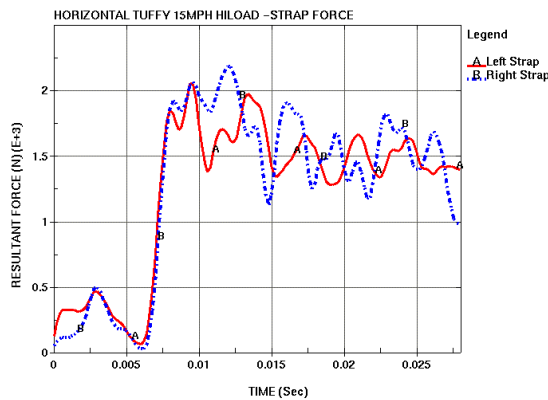

Figure 12. Strap Force vs Time Plot

The strap force variation with respect to time is plotted in figure.12 for left and right straps.

Full Sled System Evaluation

The finite element model of a sled system is shown in figure 13. In this system model, a 50th percentile LSTC dummy was used. Also, the driver side air bag was included

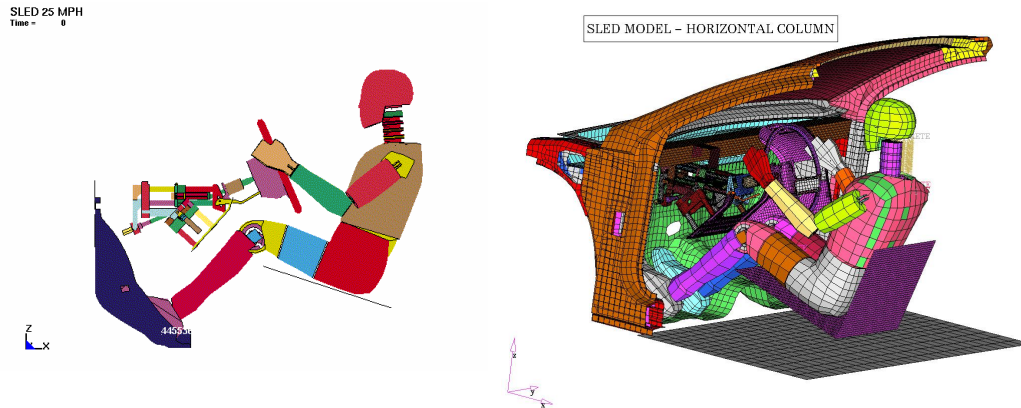

Figure 13. FE Sled Model.

The system level performance was evaluated using the sled model shown in figure 13. The femur load developed is shown in figure 14.

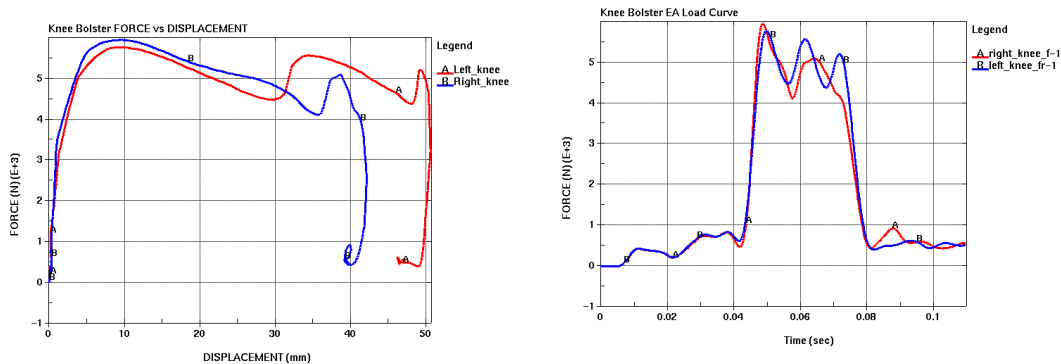

Figure 14. Knee Bolster Force plots

Remarks and Conclusion

The development of a Delphi Driver Protection Module (DDPM) using systems engineering approach was outlined. The LS-DYNA CAE analysis code was used in virtual prototyping. Various options of LS-DYNA such as static analysis, vibration analysis and impact analyses were used in this development.

Component level designs were analyzed and any deficiency in the design was identified before physical prototype build. The component designs were validated to certain extent with experimental tests. A sub-system model based on body block was developed to evaluate the assembled column performance. Once the sub-system model was correlated, many design changes were evaluated without actual build and this reduced the development time considerably. Full sled model was used to evaluate the performance of the DDPM in a vehicle environment to check the femur load and other injury parameters.

In conclusion, the virtual prototyping using systems engineering approach helped develop and evaluate a driver protection module in much lesser cost and time. Also, the LS-DYNA code provided tools for static, NVH, dynamic and impact analyses and this reduced time and cost in performing these analyses.

Acknowledgement

The authors wish to thank the management of DELPHI Corporation for permitting to publish this material. Also, the authors thank Wayne L. Mindle and Dilip M. Bhalsod of LSTC for their help in application of LS-DYNA software in this study.

References

1. Federal Safety Standard # 208, Crashworthiness Occupant Protection.
2. Federal Safety Standard # 203, Impact Protection for the Driver from the Steering Control System.
3. Hamid, M.S., Narayanasamy, N., Shah, M.J. and Riefe, R.K., 'Systems Approach in Development of Energy Absorbing Steering Columns by Virtual Engineering', SAE, Paper # 2005-01-0705.