

Topology & Geometry Based Structure Optimization using Implicit Parametric Models¹ and LS-OPT

7th European LS-DYNA Conference
14th-15th May 2009
Salzburg

H.Zimmer², M.Prabhuwaingankar³, F.Duddeck⁴

Abstract

Today's vehicle development process demands for quick evaluation of new designs considering the various attributes in the conceptual phase. Various CAx tools and methods are essential to realize these assessments in a very narrow time frame. New design variants with desired criteria should be quickly created and analyzed. Beside NVH behavior and other criteria crash safety needs to be addressed too as early as possible. Synergy in CAE analysis and geometry description is an absolute necessity for a seamless vehicle development process. Where to position beads and how to shape these beads considering the design space and manufacture criteria is a challenging task. Geometry based shape and topology optimization is an enabler for such a seamless vehicle development process. Function driven geometry and geometric requirements based on other criteria are the key factors to determine the design space and the non-design space.

Application of realistic load cases based on experience and best practices is a prerequisite for optimization. The geometry based topology and shape optimization offers the necessary flexibility in proposing new design alternatives by modifying the geometry and respecting the manufacturability aspects. This procedure includes more valuable "engineering" information compared to the knowledge of "material distribution" of the standard topology optimization.

This paper describes the feasibility of above mentioned seamless vehicle development network where CAE analyses and geometry description go hand in hand. To demonstrate this, optimization of a crash box of a car body structure by inserting and optimizing the position and shape of beads is carried out.

¹ Keywords 1: Car body, Concept stage, Implicit Parametric, Shape optimization, Topology optimization, Crash safety, optimization, Manufacturing parameters, Batch meshing, SFE CONCEPT, LSOPT, LS-DYNA

² SFE GmbH, Voltastr. 5, 13355 Berlin, Hans Zimmer, President & CEO SFE GmbH, Tel: +49-30-4677670, mailto: h.zimmer@sfe-berlin.de

³ SFE GmbH, Voltastr. 5, 13355 Berlin, Manohar Prabhuwaingankar, Vice President SFE North America, Tel: +49-30-4677670, mailto: prabhu@sfe-usa.com

⁴ Dr. habil. Fabian Duddeck; Reader for Computational Mechanics; Maître de Conférences; Privatdozent, mailto: f.duddeck@qmul.ac.uk |

1 Introduction

Vehicles being designed today and for future need to conform to new regulations and requirements for attributes like crash safety, comfort, manufacturing techniques and also take into account intelligent usage of energy reserves through extremely lighter designs and implementation of alternative fuel concepts. These requirements often result in target conflicts which should be recognized and resolved in the concept finding stage itself.

Vehicle development may start based on a predecessor model as reference or it may begin from scratch with no predecessor model as reference. These two development scenarios differ from each other. In development based on predecessor usually the vehicle architecture / topology is unchanged or identical. Thus the existing components or modules may be fitted to the new design. However for development from scratch the new vehicle architecture / topology should be realized based on available information. Vehicle parameters, exterior dimensions, boundary conditions, manufacturing techniques, assembly techniques, available package and styling data are part of the available information. Generally speaking the information may also include "real scalar" values like wheel base or fuel capacity or may also include "abstract" values like vehicle type or legal regulations. It should be able to analyze and associatively process this available information in an integrated CAE / CAD environment (refer figure 1.1).

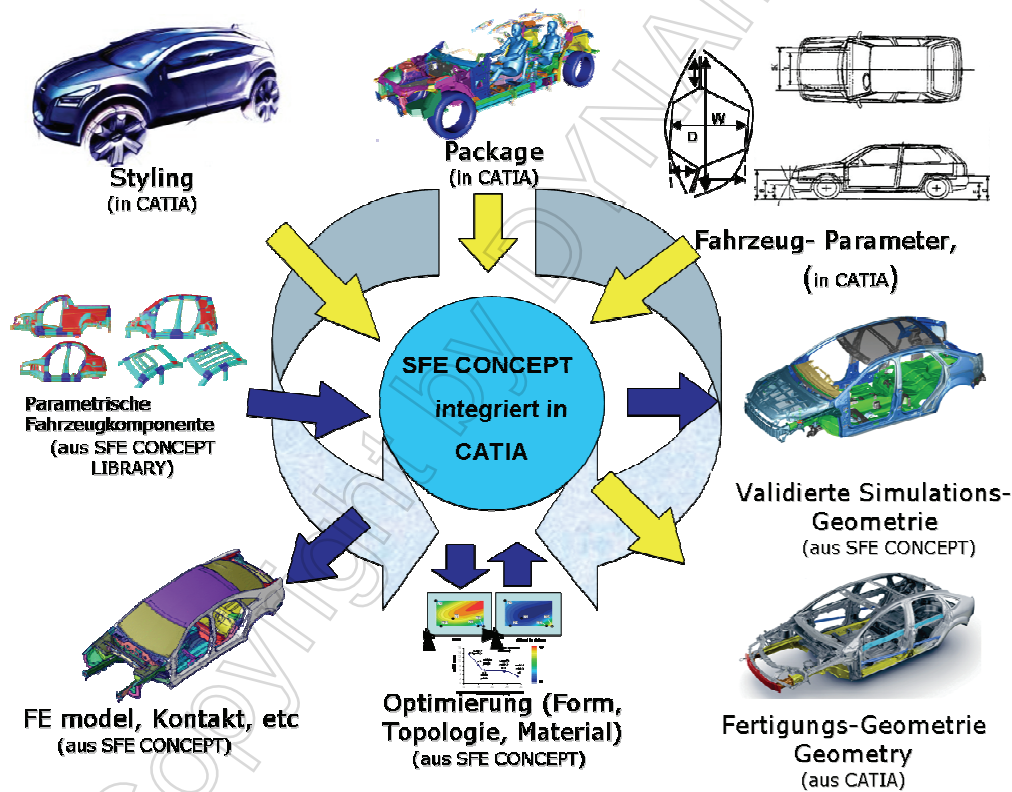

Figure 1.1: Integrated CAE / CAD Process

In functionality driven development process a reasonably accurate parametric geometry needs to be created based on the available design information. This process should be quick and also create the required FE models with proper connections (spot welds, adhesives, etc.). Application of size, shape, topology and material optimization techniques in a closed loop must ideally support the new development of new vehicles. In totality this is only possible if the design space description and the parametric geometric entities spanning the design space can be brought into association.

Today, application of SFE CONCEPT a parametric design tool enables rapid development and modifications of structure models in concept development phase. Degree of details for such models can be progressively increased (model refinement) to suit the analysis type under consideration (Crash, NVH, etc). The details added to the model are also implicitly parameterized. The resulting FE models are free of any initial penetrations and conform to the element quality criterion. Full advantage of the available information can be taken without overloading the analysis models with unnecessary

details. The influence of available information on the analysis can be evaluated in real sense as this plays an important role (see figure 1.2). Even in case of lack of details which is typical for early design phase parametric geometry models can be created using the available design space, topology/architecture, styling and packaging information.

The topology & geometry models are thus not to be considered in isolation but should be respected for the value they bring to functional assessment. Standardization, communization and interchangeability of components within vehicle families should also be addressed.

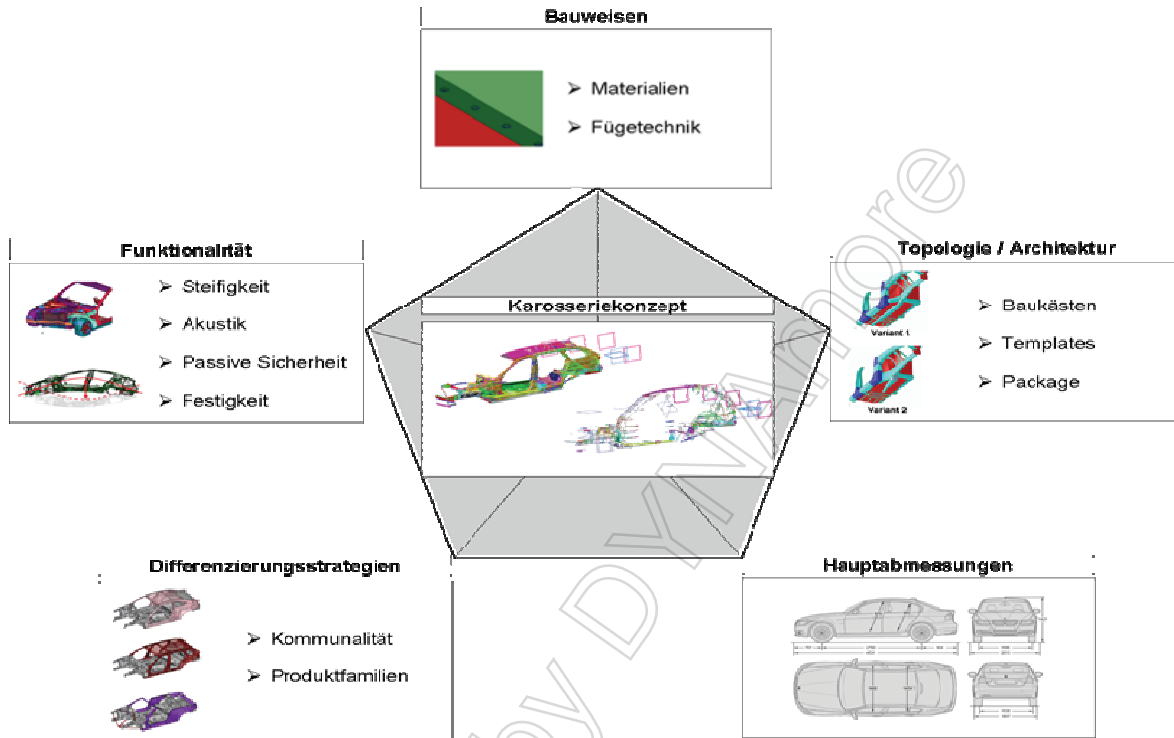

Figure 1.2: Factors influencing vehicle concept development (Source: BMW AG{12})

2 Review of methods used in conceptual design phase

Up to now, concept finding has been a challenge for the development teams of OEMs. Some articles clearly describe the requirements, methods and goals in the conceptual design phase {2, 3}. Simple design formulas fascinate by their "apparent" simplicity and extremely short response times. It is, however, questionable whether the increasingly complex nature of models (e.g. due to new materials and manufacturing techniques) can be reduced to "simple" design formulas and the validity of "quality and worth" of the results. Furthermore, there is also reason to ask why the available topology and geometry information should not be used if the quick and implicitly parametric provision of this information is possible.

Besides design formulas, design grammars are also discussed today. Design grammars are a very abstract description of a draft/design. It remains, however, questionable whether the topology and geometry which is derived therefrom can be influenced by the concept engineer. The use of design grammars must be judged by the one-to-one correspondence of the geometric model derived therefrom and the ease of handling the topological and geometrical relationship. This relationship must be "transparent" as a precondition for the concept engineer to identify important influence variables of the concept finding process in retrospect.

In SFE CONCEPT, implicitly parametric topology and geometry models are based on a pertinent "design grammar" in conjunction with the modular construction technique. This implicit design grammar enables the assembly of encapsulated components and parts stored in SFE CONCEPT modular construction library (see figure 2.1). The only difference compared to the above-mentioned is that the topological and geometrical relationship can be easily overviewed and influenced by the concept engineer who does not have to translate complex mapping rules into a mathematical description.

In this context, it is also possible to couple parametric models having different degree of details with existing FE components or part models.

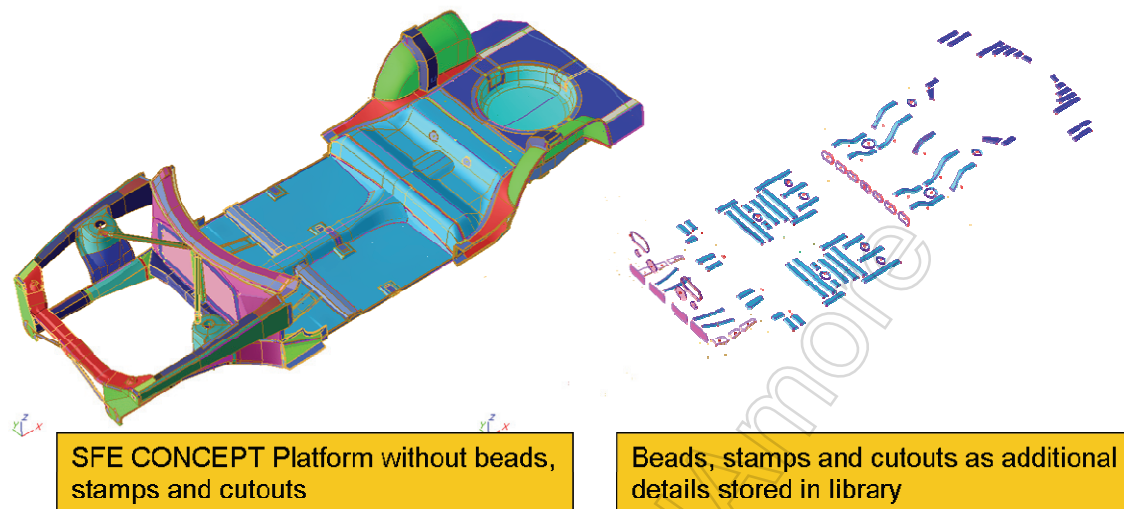

Figure 2.1: Additive parametric details (Stamping technique in SFE CONCEPT)

3 Concept finding in conjunction with optimization

Despite the many options, shape and topology optimization was so far almost not practicable for realistic simulation models. The detour via beam and beam/spring models, where cross-section optimization was just a sizing problem, enabled the limited handling of this problem class. However, the main problems of these models are reduced forecasting capability and the restriction to linear stiffness analysis. Optimization for certain disciplines, such as passive safety, was not possible with these models.

The ability to perform shape optimization for car body structure design had so far many hurdles. This option was missed badly, especially in the early design phases even though the design space was available.

The main hurdle for shape optimization of realistic car body models – i.e. models with a deviation of just a few percent between experiment and analysis – which primarily consist of shell and/or solid elements was the lack of infrastructure for generating the shape variables. What was lacking was a "geometry engine" that is capable of generating a pertinent simulation model from any set of parameters. SFE CONCEPT is able to perform the function of this "geometry engine" to study the influence of shape change on the attributes in optimization (see figure 3.1).

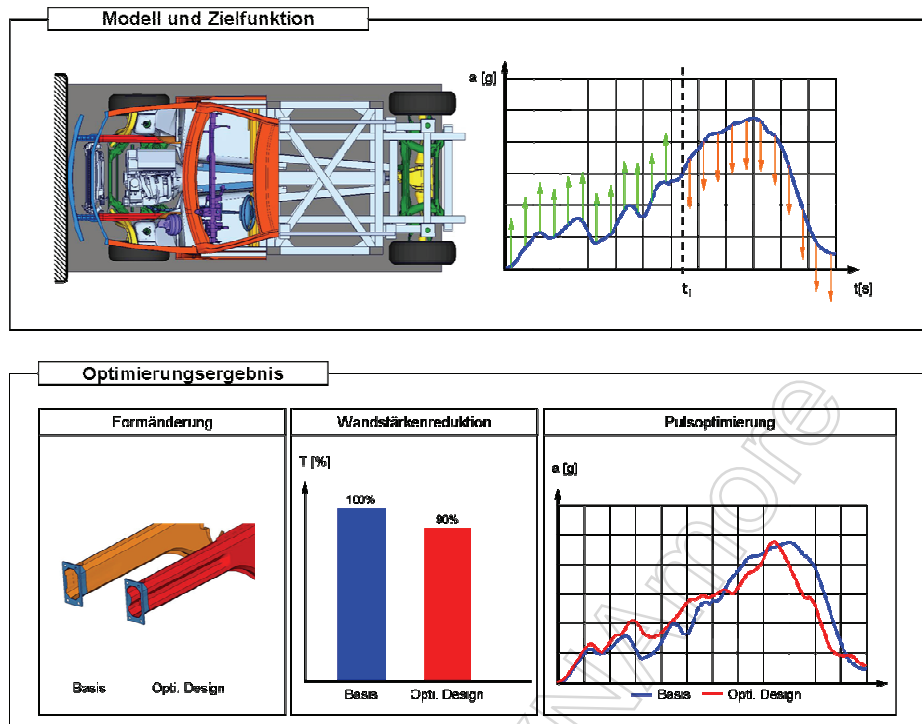

Figure 3.1: influence of shape & attribute optimization - Crash (Source: BMW AG {12})

The basic difficulty in shape optimization is the fully automatic generation of a complete analysis model from a pre-defined set of parameters. This generation process may, in principle, well be a multi-stage process. The greatest difficulty is to get a consistent FE model. Up till now, the generation of FE meshes, for a BiW model or for a full vehicle model was a semi-automatic process. This process hence required high degree of human interaction. Besides the clean-up and meshing of a CAD-based geometry, this particularly concerned the integration of loads and boundary conditions. In the case of a simple change in sheet thickness, just a single value needs to be changed in the respective model (or file). In case of shape optimization, this process is much more complex. In figure 3.2 it can be seen that the cross member is not only translated in space but it also conforms to the exterior styling of the engine hood. This is a complex modification in 3D space within defined bounds.

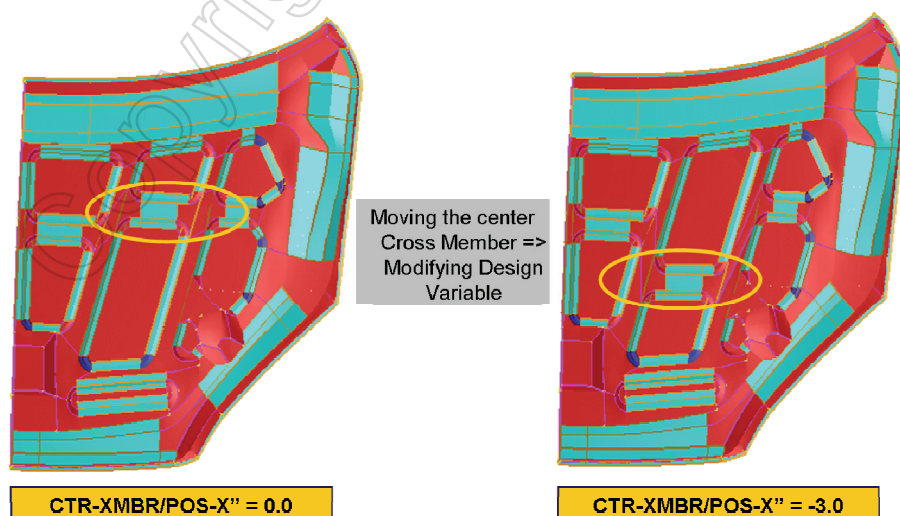

Figure 3.2: Optimization of engine hood for pedestrian safety using parametric model (Source: FORD {11})

3.1 Limitations of morphing techniques

Morphing techniques try to transform one shape to another by changing the FE node coordinates. To this effect, all nodes affected by a change in shape are transformed. Compared to sizing variables for describing changes in sheet thickness, the degree of complexity increases drastically in this case because there is no longer a simple "one to one" relationship between the parameter and the real value in the model description. A shape parameter will typically require modifying several node coordinates at the same time and with different weights. The change in nodal coordinates associated with a shape parameter is called the *shape vector*. Node coordinates can be referenced by several parameters. Generally speaking, each node coordinate is hence a function of all shape parameters. Morphing techniques are well suited for infinitesimal changes in shape parameters. In the case of major changes, however, they quickly become obsolete or can be used with extreme limitations only. The reason for this is the mesh quality which typically deteriorates significantly in the case of major parameter changes. As a matter of fact, stiffness calculations may still be performed. The optimization results, however, must be considered to be critical because the numerical optimization is unable to determine whether a potential increase in stiffness is due to *true* stiffening or caused by *bad* elements that violate the element quality criteria. Non-linear analysis and/or analysis with explicit time steps – such as crash analysis for passive safety - are nearly impossible with *morphed* models. If elements are too small, CPU time increases to infinity whilst in the case of elements which are too large, the buckling behavior which is very important for crash calculations is incorrect. In the case of too small a change in parameters in crash analyses, result *scatter* increases.

4 Implementation with SFE CONCEPT

4.1 General procedure

SFE CONCEPT is based on a consistent description of the vehicle topology. The topology-based approach ensures that the pertinent geometry and/or change in geometry *automatically* follows the topological description. A vehicle model created using SFE CONCEPT is not only fully *parametric*, but the parametrics also spans over various component ranges. This is an important precondition for CAE to be able to *drive* the design during the early phase. The generation and quick modification of models without the availability of CAD data is made possible {4} (see figure 4.1 to 4.3). SFE CONCEPT can be used both in interactive mode {5, 6} and in batch mode. The latter also enables its use in shape optimization {7, 8}.

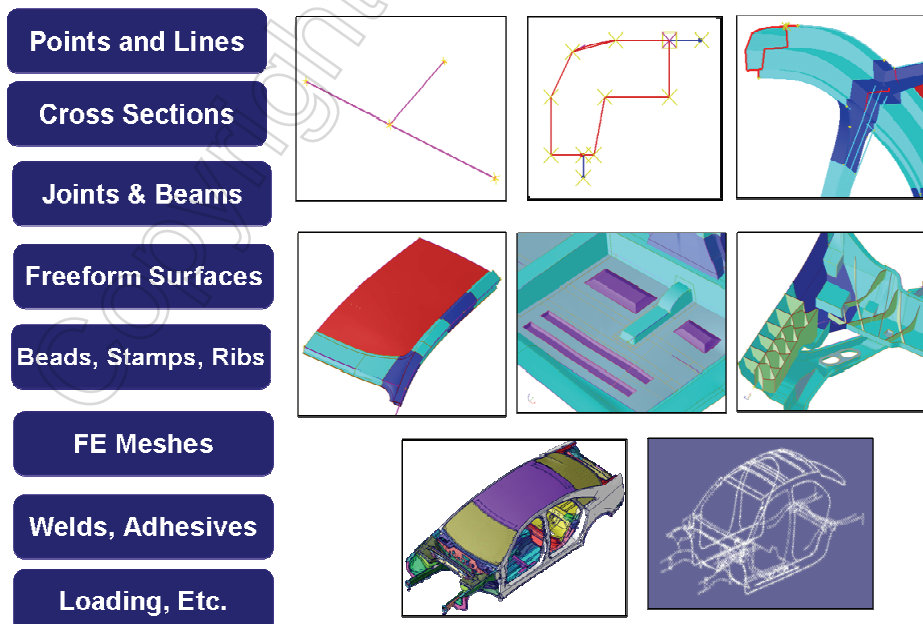

Figure 4.1: SFE CONCEPT objects

Points → Lines → Sections → Beams → Joints → Surfaces → Mesh

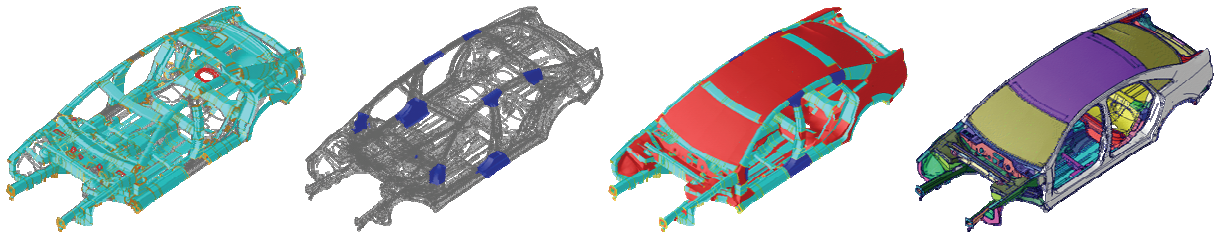

Figure 4.2: Sequence of model creation in SFE CONCEPT

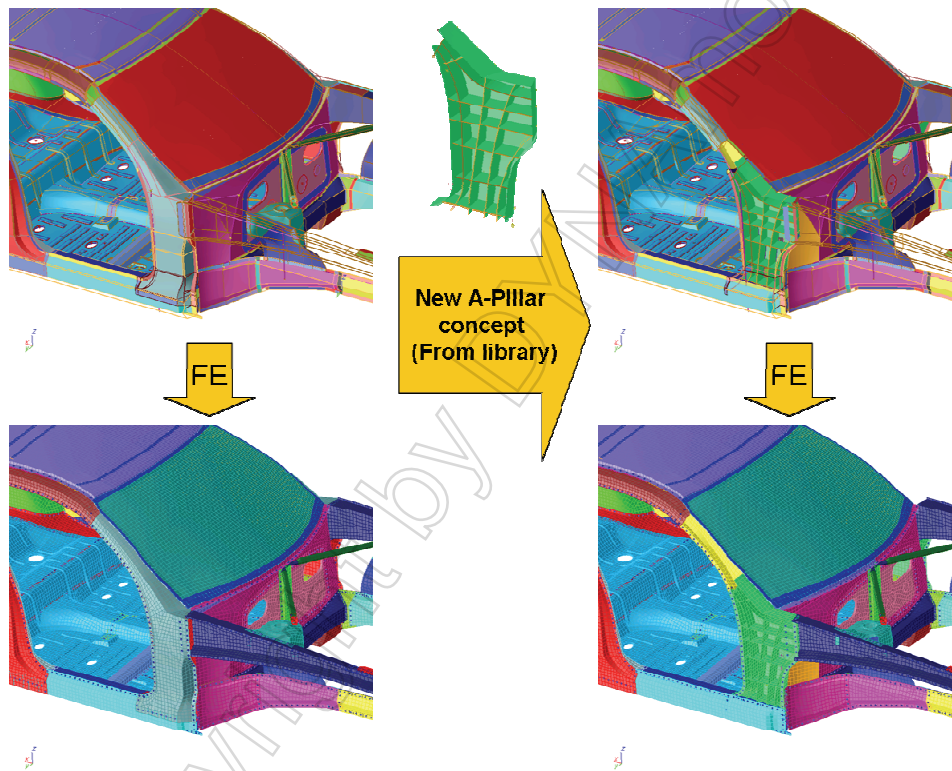

Figure 4.3: Material substitution in A-Pillar

Thanks to automesh which generates the FE mesh on the underlying geometry, in SFE CONCEPT it is possible to link change in geometry and the resulting modification of FE mesh nodes, i.e. to determine the *shape basis vector*. The description of the *shape basis vector* is indispensable for gradient-based optimization.

Both the available *shape basis vectors* and the updated analysis model can be passed on to the FE solver.

After adapting the geometry and/or topology model to the updated design increments, the "real" geometry is remeshed rather than morphing the previous FE mesh without any relationship to the updated geometry.

4.2 Problem definition

In SFE CONCEPT, design variables can be defined using the so-called "records". The user modifies the geometry interactively and the changes are recorded. Since the model in SFE CONCEPT is fully parametric, any geometry changes can be implemented, such as scaling of individual cross-sections, modifying points or lines, changes in tangents, etc. It is also possible to combine several geometric changes to one design variable. The graphical user interface (GUI) in SFE CONCEPT can be used to define the upper and lower bounds for the design variables.

Control scripts for the FE solver to be used can be imported in SFE CONCEPT. The objective function and constraints must be defined therein.

4.3 Presenting optimization process with SFE CONCEPT

The optimization process with SFE CONCEPT combined with a suitable FE solver and/or an external optimization tool consists of so-called *inner loops* and *outer loops*.

To start with, an FE mesh and, if applicable, the pertinent *shape base vectors* are automatically generated from the SFE CONCEPT geometry model. With this information, an optimization run can be started using the FE solver. In the *inner loops*, the design variables with regards to the objective function and constraints are iterated. The optimization is aborted when a predefined convergence criterion is fulfilled, when the maximum number of *inner loops* is reached or when an error due to element distortion occurs. Within the *inner loops*, the FE mesh is modified whilst adhering to the element quality criteria defined in the FE solver.

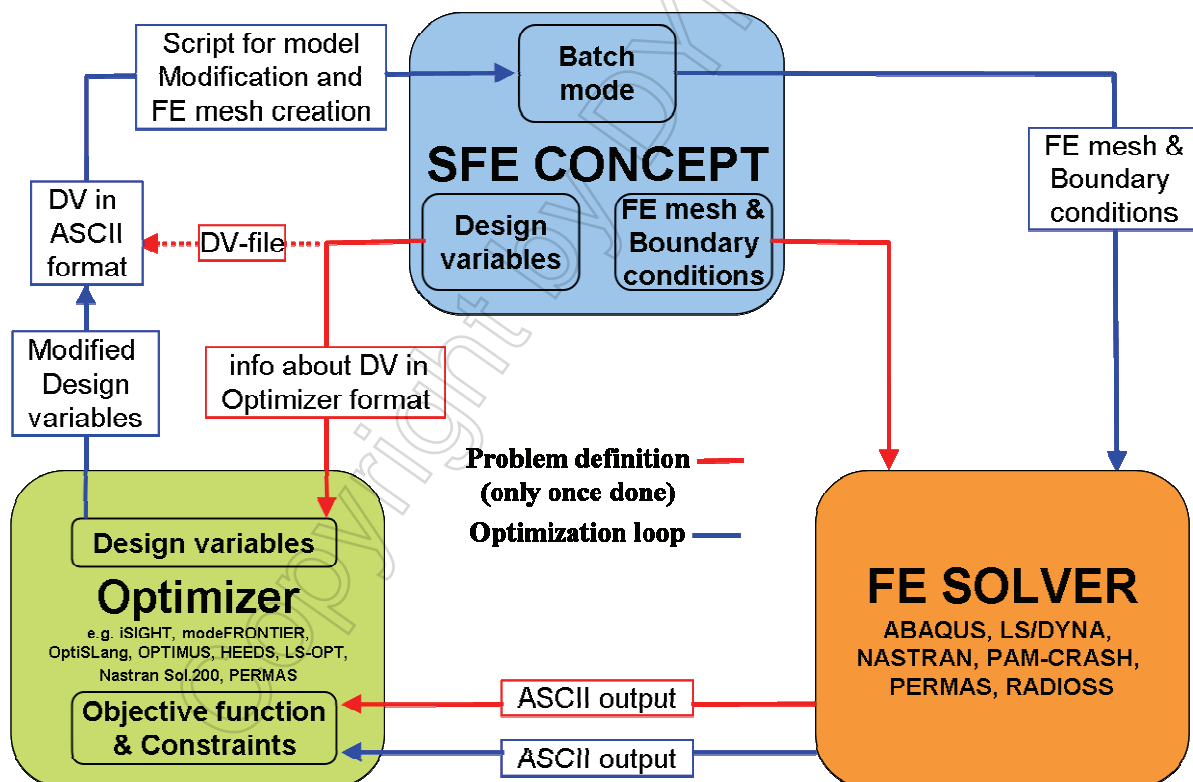

Figure 4.4: Optimization process with SFE CONCEPT

The incremental change in design variables from FE solver or external optimization tool are automatically imported in SFE CONCEPT and the geometry is updated accordingly (refer figure 4.4). From this geometry, a new FE mesh is generated which is hence free from element distortions. This is when a new *outer loop* starts until a previously determined convergence criterion is fulfilled {9}.

The entire optimization process with multiple *outer loops* can be performed without any user intervention (see figure 4.5).

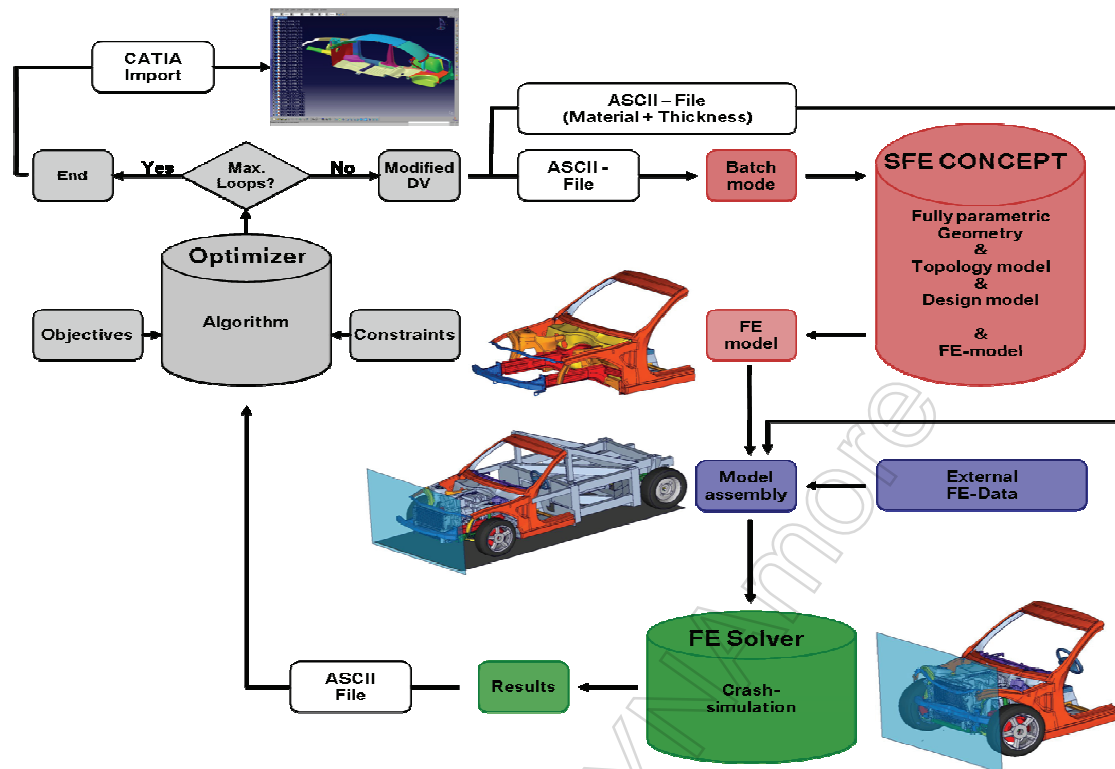

Figure 4.5: Application – SFE CONCEPT optimization process (Source: BMW , {12})

4.4 SFE CONCEPT MODULAR CONSTRUCTION TECHNIQUE

The modular construction technique in SFE CONCEPT is an excellent way of combining shape and topology optimization. With the modular construction technique, it is possible to encapsulate model parts with their topological connections, to store these in libraries, and to arrange them in a new configuration based on user-defined filter criteria (refer figure 4.6 and {10}). The crucial advantage is that the encapsulated models bear attributes which ensure the unambiguous topological and geometrical compatibility to other modules.

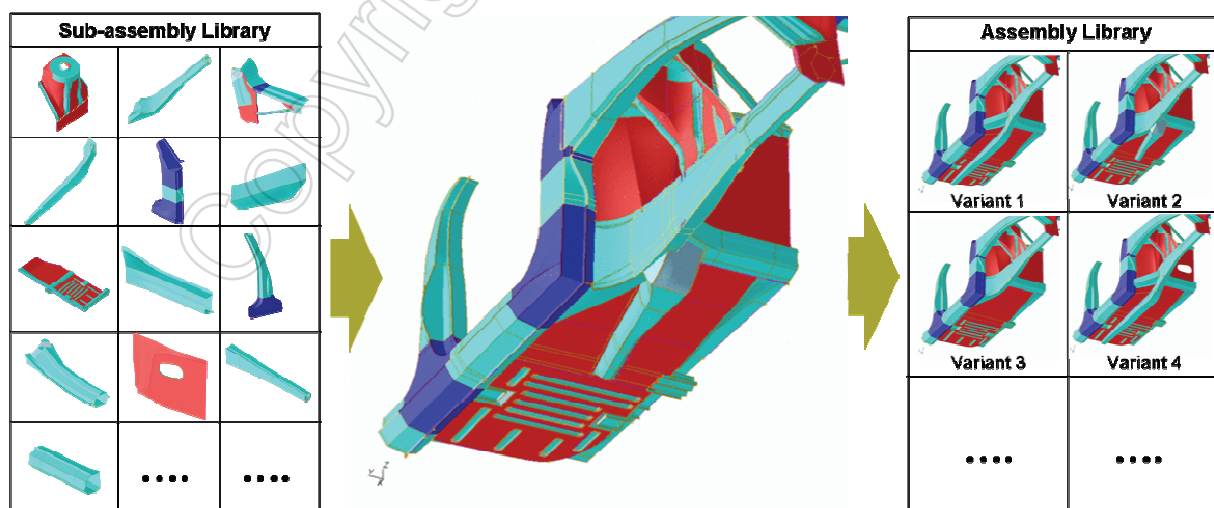

Figure 4.6: Modular Construction Library in SFE CONCEPT

Predefined modules can be combined to create new configurations, just like using a construction kit system. In this context, the construction kit system can be used to combine modules from different

vehicle platforms and vehicle types. In order to ensure geometrical compatibility, the dimensions of the components are automatically adapted using mapping rules (see figure 4.7).

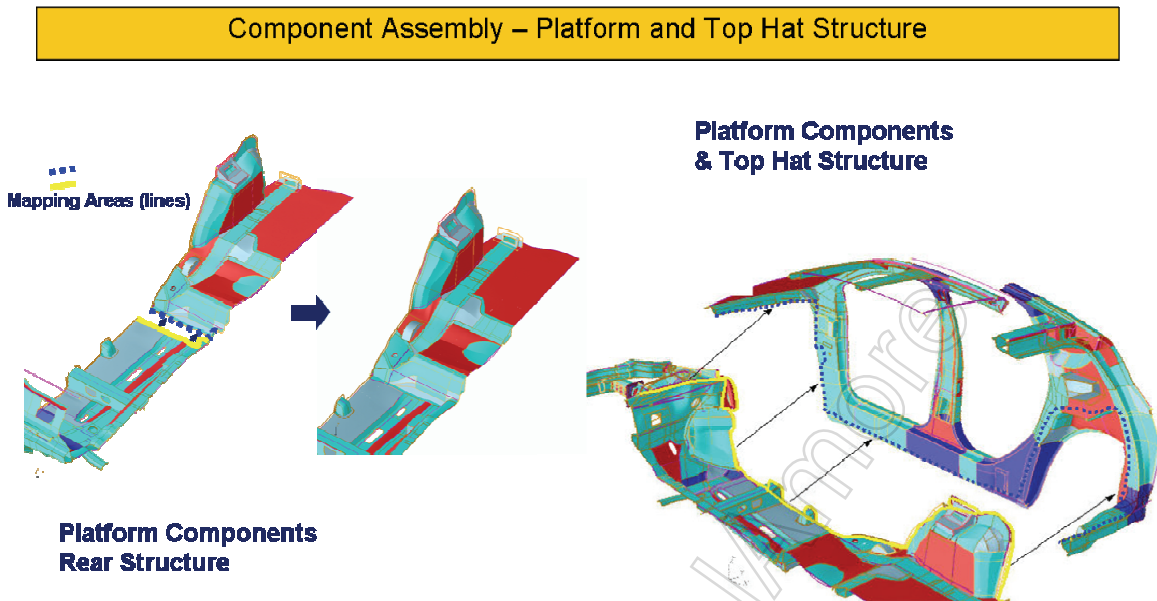

Figure 4.7: SFE CONCEPT library application (Source: FORD {11})

The connectivity of neighbouring components is automatically done. This is made possible by using a corporate specific naming convention of parametric components (see figure 4.8). Components are automatically positioned and proportioned depending on the available space.

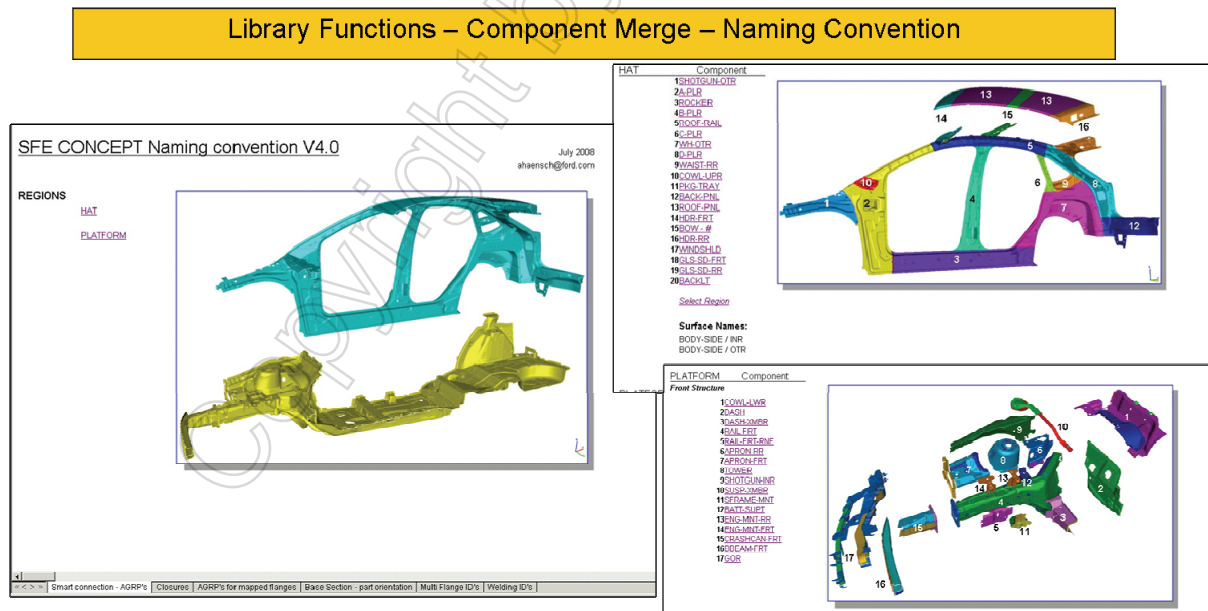

Figure 4.8: Corporate specific naming convention for model library and automated assembly (Source: FORD {11})

4.5 Component library to create model variants of a vehicle family

Model variants for a vehicle family can be easily created using the logic and information stored in encapsulated parametric models in the library. Naming convention plays a special role in model assembly. Common or carry-over parts can be considered as frozen and can be connected to the parametric (modifiable) parts. An analysis model can be quickly created with this combination. Die

Figure 4.9 and 4.10 show the usage of library to create model variant in a vehicle family. Topological and geometrical modifications can be done on the parametric models to create new variants. Various platform and top hat models can be combined to generate the FE models for analysis.

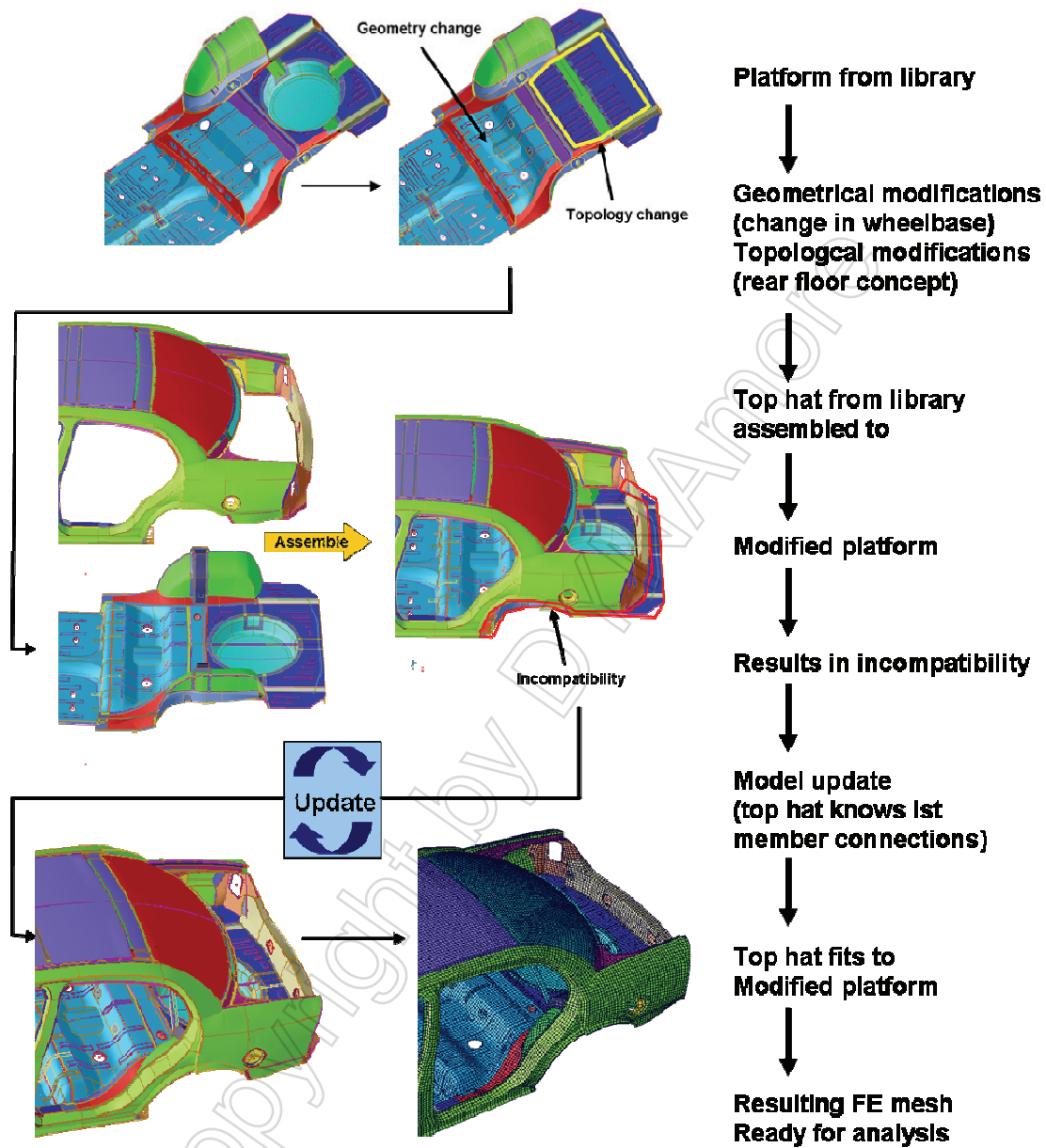

Figure 4.9: Model modifications using library

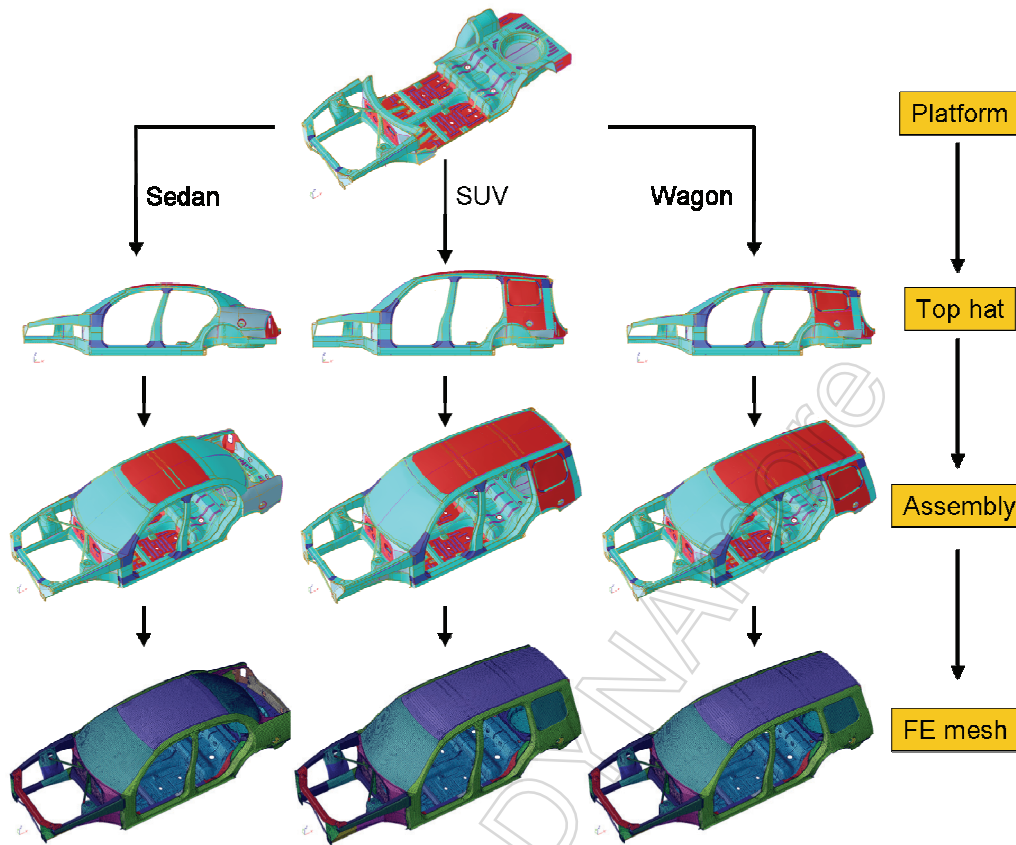

Figure 4.10: Vehicle family and their FE models

4.6 Application - Optimization for Crash

Application of the optimization process for crash box is shown below. Topological (adding/deleting) and geometrical modifications of beads in the crash box is carried out in a closed batch loop. Design variables and design space can be easily defined in SFE CONCEPT. The red path in following figure defines the initialization loop which is a one time effort and the blue path depicts the automated procedure.

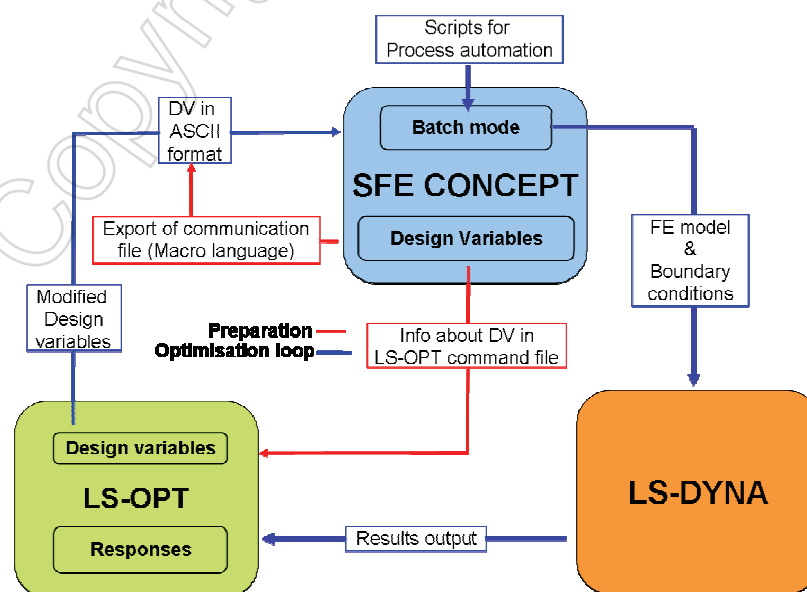

Figure 4.11: Optimization with SFE CONCEPT – LSOPT and LSDYNA

Figure 4.12 clearly shows the possible design variables like number, size, shape and position of beads. Analysis models can be sent to LS-DYNA and the design variables can be exported to LS-OPT.

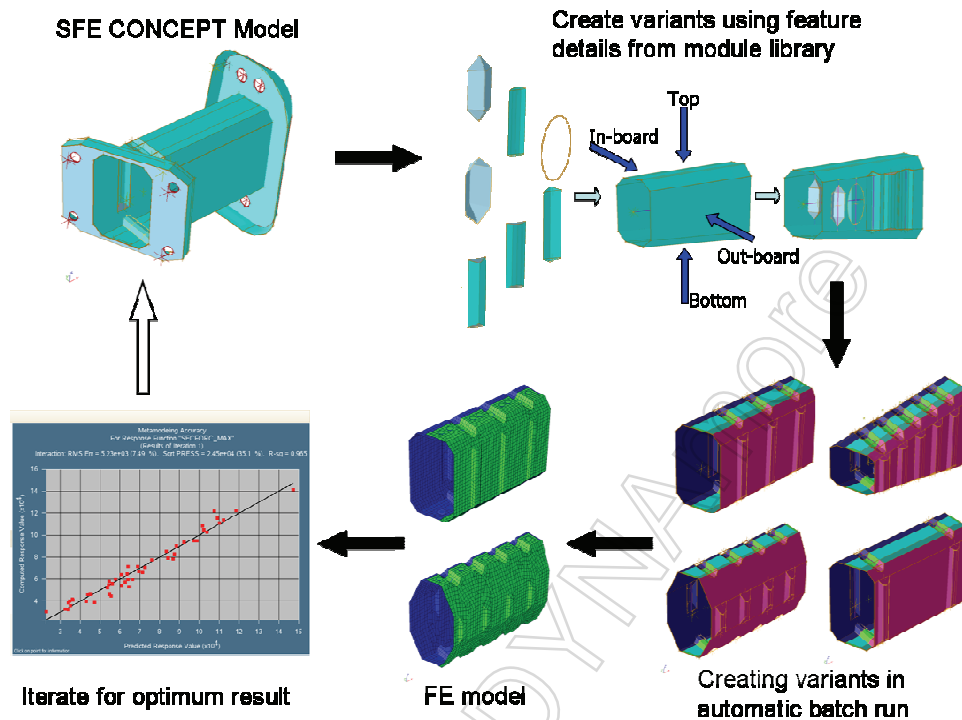

Figure 4.12: Crash-Box with design variables

The shape variables can be length, depth, width, curvature and position of beads. Figure 4.13 shows a real life application of the above mentioned procedure [11].

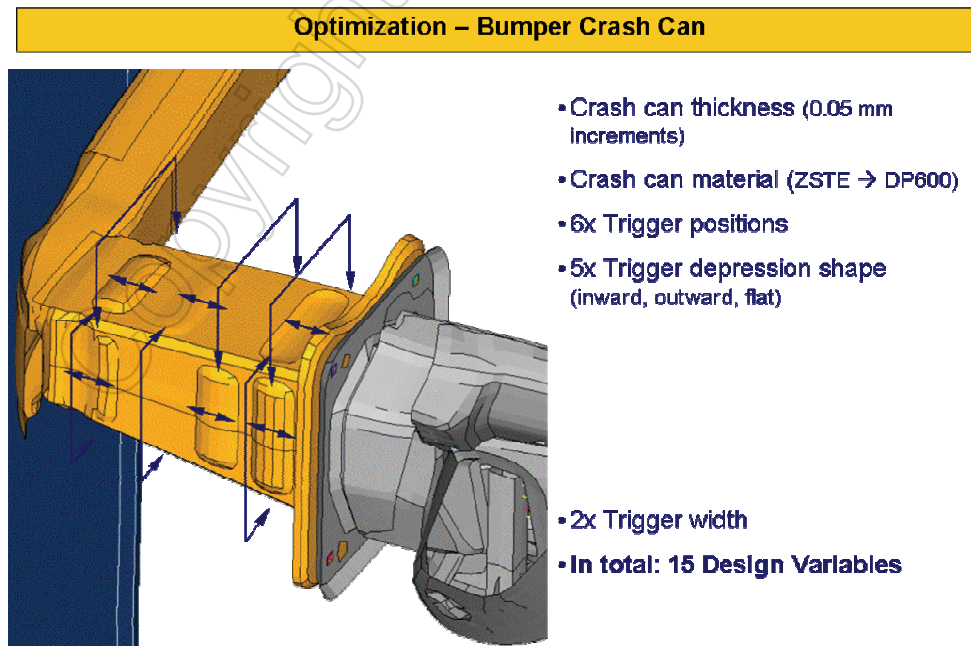

Figure 4.13: Application example – Optimization process with SFE CONCEPT (Source: FORD)

5 Summary

Integration of CAE and CAD applications in vehicle development is an important precondition to do justice to today's demanding VPD (Virtual Product Development). Requirement of lighter vehicles fulfilling all the functional aspects and challenges posed by new fuel concepts make the integration of "form & function" inevitable.

SFE CONCEPT, in conjunction with shape optimization and topology optimization, provides efficient techniques and tools for vehicle development in the early phase.

With tighter integration *SFE CONCEPT* in CATIA enables associative design & development of full car bodies using package, styling and vehicle parameters and thus not only limited to component design in isolation. Thus form and function go hand in hand.

Implicitly parametric topology and geometry models enable CRASH and NVH analyses to be performed during the early stages of vehicle development. The analysis models and design models can be quickly generated for optimization. Besides the simple "modification of FE node coordinates", this also includes complete re-meshing which fulfills the element quality criteria for the solver of choice.

Thanks to the efficient way of defining the design variables, the effort for creating the design model for optimization is drastically reduced.

This new approach opens up new frontiers for designing and optimizing lightweight vehicle structures which has since long become a mandate for the automotive industry.

6 Literature

- [1] Hänschke, A.; Paas, M.; Hilmann, J.: Vereinfachte mechanische und geometrische Ersatzmodelle zur Optimierung von Karosserie- und Gesamtfahrzeugentwürfen: Entwicklungen im Karosseriebau, Hamburg, 4.- 5.Mai 2004: VDI Berichte 1833
- [2] Schelkle, E.; Eisenhans,H.: Integration innovativer CAE-Werkzeuge in die PKW-Konzeptentwicklung: Berechnung und Simulation im Fahrzeugbau, Würzburg, 14.-15.September 2000: VDI Berichte 1559
- [3] Braess, H.-H.: Die Karosserie-typisches Beispiel für Zielkonflikte und Zielkonfliktlösungen für Automobile. VDI-Bericht 968, 1992
- [4] Zimmer,H.; Hövelmann,A.; Frodl,B.; Hänle,U.;et.al.:Entwurfstool zur Generierung parametrischer, virtueller Prototypen im Fahrzeugbau: Berechnung und Simulation im Fahrzeugbau, Würzburg, 14.-15.September 2000: VDI Berichte 1559
- [5] Stuhec,U.; Zhou,S.;Shahidi,B.;Zimmer,H.;Prabhuwaingankar,M.: CAE Concept Design-a Key Enabler in Virtual Product Development: 11th International Conference on Human-Computer Interaction, Las Vegas, Nevada USA, July 22-27,2005
- [6] Automobilentwurf durch Simulation und Optimierung; auto>opt Abschlussbericht [www.auto-opt.de] Juni 2005 ; gefördert vom BMBF Kz: 01 IR B01; Herausgeber: Fraunhofer-Institut für Algorithmen und Wissenschaftliches Rechnen SCAI
- [7] Hoppe, A.; Zimmer,H.; Widmann,U.; Papke,L.; et al: Multidisziplinäre Optimierung parametrischer Fahrzeugkomponenten: Entwicklungen im Karosseriebau, Hamburg, 4.- 5.Mai 2004: VDI Berichte 1833
- [8] Heiserer, D.; Zimmer, H.; Schäfer, M.; Holzheuer C.; Kondziella, R.: Formoptimierung in der frühen Phase der Karosserieentwicklung. Berechnung und Simulation im Fahrzeugbau, Würzburg, 29.-30.September 2004: VDI Berichte 1846
- [9] Volz, K.; Frodl, B.; Dirschmid, R.; Stryczek, R.; Zimmer, H.: Optimizing Topology and Shape for Crashworthiness in Vehicle Product Development International Automotive Body Congress (IABC), Berlin 2007
- [10] Zimmer, H.: *SFE CONCEPT*, bridging the gap between functional assessment and geometry exploration. NAFEMS Seminar "Reliable use of numerical Methods in Upfront Simulations, March 28-29, 2007, Wiesbaden, Germany
- [11] Hänschke, A.: Methoden und Modelle zur Gesamtfahrzeug-Optimierung – Anwendungsbeispiele und Potentiale. FAT Leichtbauforum 9. Dezember 2008 Frankfurt / M.
- [12] Meyer, O.: Systemintegration mit Werkzeugen der virtuellen Produktentstehung. VDI-Fachtagung, Karosseriekongress-Systemintegration in der Karosserietechnik, 17-18 März 2009 Baden-Baden