

Introduction of LS-DYNA[®] MCOL solver coupling with Ansys Aqwa for the application in shipbuilding analysis

Zhe Cui, Yu Bi, Arwel Davies, Shuangxing Du, Yun Huang

Ansys, Inc

1 Introduction

For the ship building industry, ship accidents continue to occur regardless of efforts to prevent them. Some extreme or accidental situations such as collision and grounding need to be considered at the design stage. The rigid body dynamic program MCOL was developed in LS-DYNA and used in simulation of ship collisions analysis.

The MCOL solver requires an input file as .mco file containing the hydrodynamic parameters such as the rigid body added mass matrix, hydrostatic restoring matrix, buoyancy parameters, and wave damping matrices for the body, etc. These parameters were provided by third-party software previously. In this paper, the new development on LS-DYNA/MCOL-Aqwa coupling analysis has been implemented in which the Aqwa solver can automatically create the MCOL required hydrodynamic database, .mco file.

2 LS-DYNA/MCOL approach

The ship-ship collision mechanics can be subdivided into inner collision mechanics and outer collision dynamics. The inner collision mechanics is a crash problem governed by buckling, yielding materials and assemblies. It is investigated using the explicit finite element code LS-DYNA. Collision forces are computed at this step. The outer collision dynamics, i.e. global motions of the two ships considered as rigid bodies under collision forces and hydrodynamic pressure forces, are computed with the program MCOL, coupled with LS-DYNA. Hydrodynamic loads are calculated with the hydrostatic restoring matrix, the added mass matrix and the frequency dependent added damping matrices computed for each ship by the third-party code.

A model of the collision analysis is shown on figure 1. Only the collision areas of ships and ice impinged on are meshed, the remaining structure being modeled by a rigid body described by its inertia matrix and the position of its center of mass.

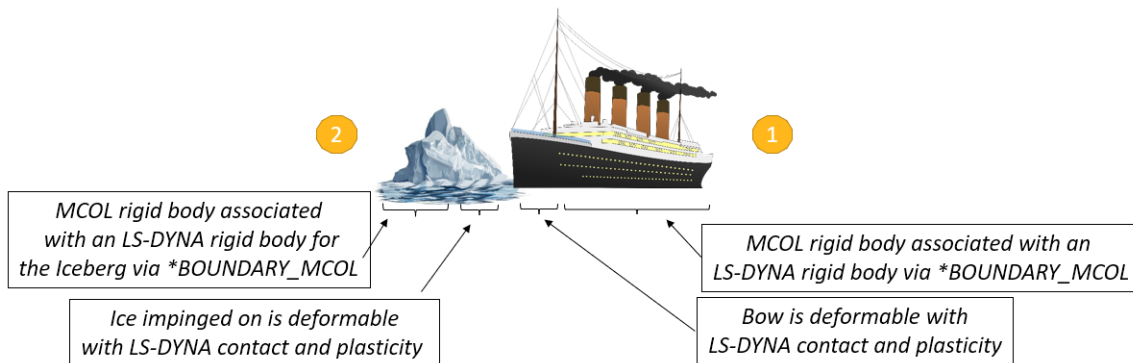

Fig.1: LS-DYNA/MCOL collision simulation approach.

The MCOL solver is a rigid body mechanics program for modeling the dynamics of ships and is activated by the keyword ***BOUNDARY_MCOL** (shown in figure 2) in LS-DYNA which is used to define parameters for MCOL coupling.

The basis for MCOL is a convolution integral approach for simulating the equations of motion. A mass and inertia tensor are required as input for each ship. The masses are then augmented to include the effects of the mass of the surrounding water. A separate program determines the various terms of the

damping/buoyancy force formulas which are also input to MCOL. The coupling is accomplished in a simple manner: at each timestep LS-DYNA computes the resultant forces and moments on the MCOL rigid bodies and passes them to MCOL. MCOL then updates the positions of the ships and returns the new rigid body locations to LS-DYNA.

Card 1	1	2	3	4	5	6	7	8
Variable	NMCOL	MXSTEP	ETMCOL	TSUBC	PRTMCOL			
Type	I	I	F	F	F			
Default	2	none	0.0	0.0	none			
Remarks			2					

Fig.2: *BOUNDARY_MCOL (see LS-DYNA keyword manual R15 [4])

3 Introduction of Ansys® Aqwa™

Ansys® Aqwa™ application is an industry recognized software, which provides a toolset for investigating the effects of environmental loads on floating and fixed offshore and marine structures. In Ansys Aqwa Workbench, it has the Hydrodynamic Diffraction and Hydrodynamic Response analyses. Hydrodynamic Diffraction provides an integrated environment for developing the primary frequency domain hydrodynamic parameters required for undertaking complex motions and response analyses. Hydrodynamic Response provides dynamic analysis capabilities for undertaking global performance assessment of floating structures.

Hydrodynamic Diffraction and time domain Hydrodynamic Response calculations can generate pressure and inertial loading for use in a structural analysis as part of the vessel hull design process. A co-simulation system with Ansys Rigid Dynamics and Aqwa creates a more powerful simulation for solving marine structures which have complex contact and gear components and conducting Hydro-Aero-Multi-body coupling analyses of floating offshore wind turbine responses by including a third-party aerodynamic module AeroDyn.

Hydrodynamic Diffraction analysis employs the three-dimensional radiation/diffraction theory in regular waves in the frequency domain, in which a fixed reference axes is defined by a right handed coordinate system with the origin in the mean water level and Z-axis point vertically upwards.

The hydrostatic force and moment acting on a body when placed in still water can be calculated by integrating the hydrostatic pressure over the wetted surface of the body, up to the still water level. The hydrostatic moments are taken about the centre of gravity of the body. The expressions for hydrostatic force and moment are

$$\begin{aligned}\vec{F}_{hys} &= - \int_{S_0} p_s \vec{n} dS, \\ \vec{M}_{hys} &= - \int_{S_0} p_s (\vec{r} \times \vec{n}) dS,\end{aligned}\tag{1}$$

where $p_s = -\rho g Z$ represents the hydrostatic pressure and $\vec{r} = \vec{X} - \vec{X}_g$ represents the position vector of a point on the hull surface with respect to the centre of gravity in the fixed reference axes.

The vertical component of the hydrostatic force vector in Equation (1) is the buoyancy of submerged body.

The hydrostatic stiffness matrix is expressed in terms of motions about the centre of gravity, and only the hydrostatic pressure is considered, the matrix will take the form:

$$K_{hys} = \begin{bmatrix} 0 & 0 & 0 & 0 & 0 & 0 \\ 0 & 0 & 0 & 0 & 0 & 0 \\ 0 & 0 & K_{33} & K_{34} & K_{35} & 0 \\ 0 & 0 & K_{43} & K_{44} & K_{45} & K_{46} \\ 0 & 0 & K_{53} & K_{54} & K_{55} & K_{56} \\ 0 & 0 & 0 & 0 & 0 & 0 \end{bmatrix},\tag{2}$$

where the various terms in the stiffness matrix are:

$$\begin{aligned}
 K_{33} &= -\rho g \int_{S_0} n_3 dS = \rho g A, \\
 K_{34} &= K_{43} = -\rho g \int_{S_0} (Y - Y_g) n_3 dS, \\
 K_{35} &= K_{53} = \rho g \int_{S_0} (X - X_g) n_3 dS, \\
 K_{44} &= -\rho g \int_{S_0} (Y - Y_g)^2 n_3 dS + \rho g (Z_B - Z_g) \nabla, \\
 K_{45} &= K_{54} = -\rho g \int_{S_0} (X - X_g)(Y - Y_g) n_3 dS, \\
 K_{55} &= -\rho g \int_{S_0} (X - X_g)^2 n_3 dS + \rho g (Z_B - Z_g) \nabla, \\
 K_{46} &= -\rho g (X_B - X_g) \nabla, \\
 K_{56} &= -\rho g (Y_B - Y_g) \nabla,
 \end{aligned}$$

in which A is the cut water-plane area, ∇ is the displacement and $\vec{X}_B = (X_B, Y_B, Z_B)$ is the center of buoyancy,

$$\begin{aligned}
 A &= - \int_{S_0} n_3 dS \\
 \nabla &= \int_{S_0} Z n_3 dS \\
 \vec{X}_B &= \frac{1}{\nabla} \int_{S_0} (X, Y, \frac{Z}{2}) Z n_3 dS
 \end{aligned}$$

and S_0 is the wetted surface of the body in still water, $\vec{n} = (n_1, n_2, n_3)$ is the unit normal vector of the body surface pointing outwards.

Three dimensional panel method is employed in Aqwa to estimate the hydrodynamic behaviour of a large-volume structure in waves. This method is based on the linear fluid potential theory and represent the structure surface by a series of diffraction panels.

The radiation wave potential, φ_{rj} , due to the j -th unit basic translational or rotational rigid body motion (surge, sway, heave, roll, pitch and yaw with respect to the structural COG) satisfies the Laplace equation in the fluid domain, the free surface boundary condition, the body surface condition, the finite depth water seabed condition and the far field radiation condition. Introducing the frequency domain pulsating Green's function and the source distribution over the mean wetted surface, the radiation wave potential is expressed as

$$\varphi_{rj}(\vec{X}) = \frac{1}{4\pi} \int_{S_0} \sigma_j(\vec{\xi}) G(\vec{X}, \vec{\xi}) dS, \vec{X} \in \Omega \cup S_0 \quad (3)$$

in which the source strength over the mean wetted hull surface can be determined by the j -th basic rigid body motion boundary condition.

The radiation wave force can be expressed in the real and imaginary parts, corresponding to the contributions of the added mass and wave damping coefficients

$$\begin{aligned}
 A_{jk} &= \frac{\rho}{\omega} \int_{S_0} \text{Im}[\varphi_{rk}(\vec{X})] n_j dS, \\
 B_{jk} &= -\rho \int_{S_0} \text{Re}[\varphi_{rk}(\vec{X})] n_j dS.
 \end{aligned} \quad (4)$$

in which the extended unit normal vector of six components corresponding to the six basic rigid body motions is defined as

$$\begin{aligned}
 (n_1, n_2, n_3) &= \vec{n}, \\
 (n_4, n_5, n_6) &= \vec{r} \times \vec{n}
 \end{aligned} \quad (5)$$

Aqwa Hydrodynamic Diffraction can also provide the LSDYNA-MCOL required hydrodynamic database for further ship grounding/collision analysis. The added mass matrix at the infinite frequency is directly calculated at the frequency of 100.0 rad/s.

Note that from the LSDYNA-MCOL User's Manual, the Z-axis of the MCOL earth-fixed frame points downwards and the X-axis is along the forward axis of the ship. Requiring the Aqwa model's fixed reference X-axis direction parallels to the MCOL X-axis, the Aqwa generated force/moment, added mass and damping matrices are automatically converted with respect to the MCOL earth-fixed frame. Based on the formulation and the earth-fixed frame of MCOL, the hydrostatic stiffness matrix is amended and converted in the Aqwa output file with the extension name of .mco.

For more information, it can be found in Ansys Aqwa theory manual 2024R2 [5].

4 Hydrodynamic case study for MCOL input generation using Ansys Aqwa

A case study was conducted using a mid-sized vessel designed to assess both its hydrodynamic behavior and structural performance. The dimensions of the ship are presented in Table 1. This section details the establishment of the Aqwa model and the creation of the MCOL input file generated by Aqwa.

Within Ansys Workbench, Aqwa Workbench is seamlessly integrated with the Ansys Geometry tool, enabling streamlined hydrodynamic diffraction and radiation analysis. For hydrodynamic diffraction and radiation analysis, the internal structures are excluded from the model. Therefore, the Aqwa geometry includes only the external hull of the vessel, represented as a shell surface without thickness, with the normal direction pointing toward the external fluid.

Dimension	Value (m)
Length	80
Width	16
Draft	5.12

Table 1: Model ship dimensions.

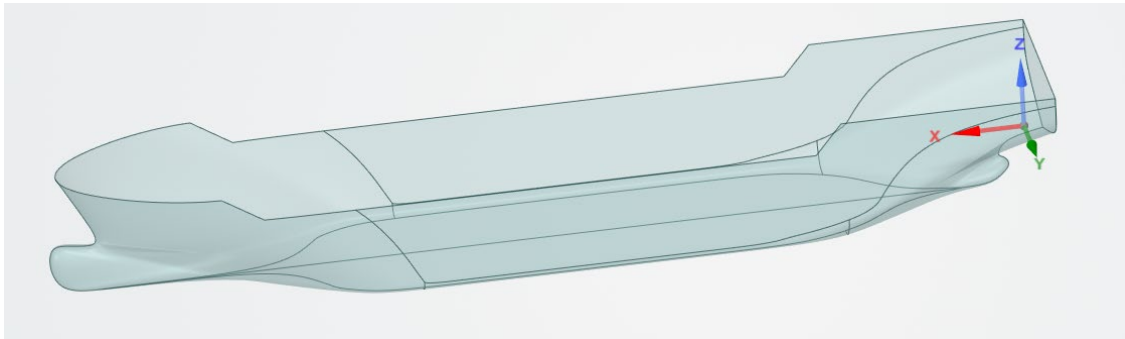

Fig.3: Aqwa geometry of the model ship.

The origin of the Aqwa global coordinate system is centered at the stern of the vessel at the waterline. The X-axis points towards the bow, the Y-axis towards the port side, and the Z-axis upwards, as shown in Figure 3.

Although the Aqwa model includes only the external hull, the mass of the vessel encompasses the structural mass, outfitting, engine, thrusters, and the deadweight of cargo distributed across six tanks. The total mass properties are detailed in Table 2.

Aqwa allows for flexible mass data input, offering the options of point mass, distributed mass, or a combination of both. Since the vessel is treated as a rigid body for MCOL calculations, simple point masses are sufficient to approximate mass distribution. In this study, six cargo point masses and one total lightweight point mass were employed. This approach not only offers flexibility in adjusting the mass distribution but also simplifies the complexity inherent in representing mass conditions. The green points in figure 4 below depict the graphical icons for point masses.

Mass properties	Values
Center of Gravity X (m)	38.75
Center of Gravity Y (m)	0
Center of Gravity Z (m)	-0.32
Total Mass (kg)	5213764
Moment of Inertia Ixx (kg.m ²)	199944116
Moment of Inertia Iyy (kg.m ²)	1694037489
Moment of Inertia Izz (kg.m ²)	1673054216

Table 2: Mass properties of the model ship.

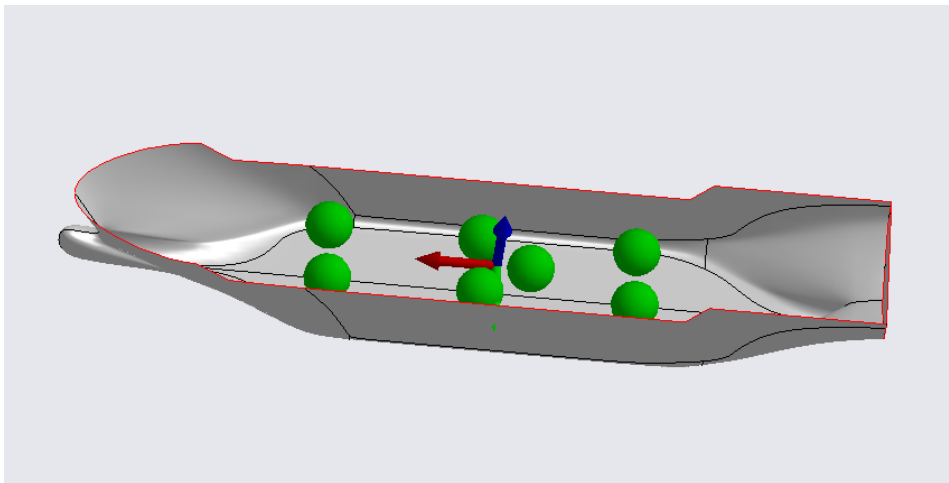

Fig.4: Aqwa model and point masses.

Aqwa integrates the advanced PRIME mesh engine from Ansys to generate meshes for shell structures. Typically, Aqwa requires meshes that are regular, smooth, and composed of linear triangular or quadrilateral elements. The mesh elements needed for hydrodynamic analysis are notably lesser than those used in Ansys LS-DYNA or Mechanical analysis.

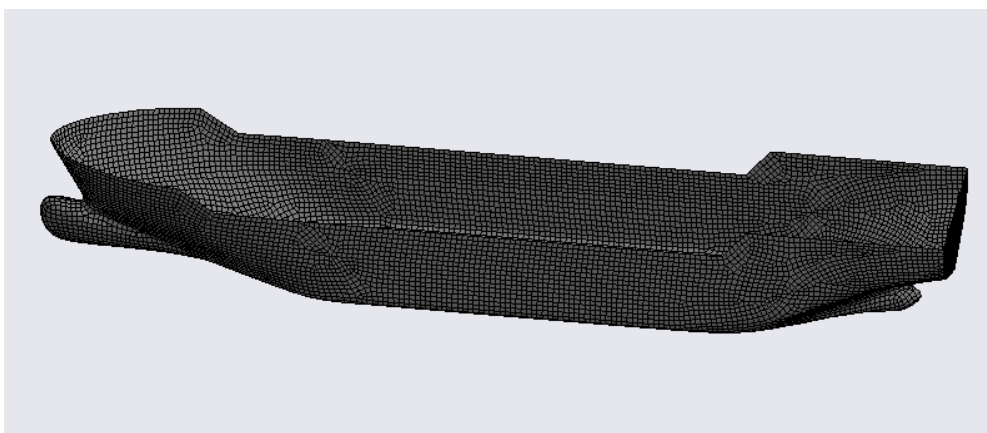

Fig.5: Aqwa mesh condition for the model ship.

Performing a hydrodynamic diffraction analysis in Aqwa with the MCOL option automatically generates an MCOL input file (*.MCO). This file contains key data required for MCOL calculations, including:
 002: Mass matrix of the ship,

003: Hydrostatic restoring matrix,
 004: Buoyancy reference parameters,
 005: Added Mass matrix,
 008: Wave damping matrixes.

These outputs represent either modeling data from Aqwa or results calculated by the Aqwa solver. Additional inputs required by the MCOL solver, which are outside the scope of Aqwa's expertise (e.g., specific user inputs or elastic analysis results), can be manually added by the user. In the following sections, we will delve into the details of each type of Aqwa output included in the *.MCO file.

4.1 Mass matrix of the ship

The mass matrix encapsulates the total mass data based on all the mass inputs within the Aqwa project. To ensure compatibility with LS-DYNA, the SI (Metric) system is adopted by the Aqwa solver. The mass matrix output, as recorded in the *.MCO file, is shown below.

```
002$rigid body mass matrix (Mrb)
0.5214E+07 0.0000E+00 0.0000E+00 0.0000E+00 0.0000E+00 0.0000E+00
0.0000E+00 0.5214E+07 0.0000E+00 0.0000E+00 0.0000E+00 0.0000E+00
0.0000E+00 0.0000E+00 0.5214E+07 0.0000E+00 0.0000E+00 0.0000E+00
0.0000E+00 0.0000E+00 0.0000E+00 0.1024E+09 0.1346E+06-0.2662E+08
0.0000E+00 0.0000E+00 0.0000E+00 0.1346E+06 0.1596E+10 0.1200E+05
0.0000E+00 0.0000E+00 0.0000E+00-0.2662E+08 0.1200E+05 0.1647E+10
```

4.2 Hydrostatic restoring matrix

Due to differences in how hydrostatic stiffness is defined, Aqwa recalculates the hydrostatic stiffness specifically for MCOL. The hydrostatic restoring matrix, as generated in the *.MCO file, is presented below.

```
003$hydrostatic restoring matrix (Ks)
0.0000E+00 0.0000E+00 0.0000E+00 0.0000E+00 0.0000E+00 0.0000E+00
0.0000E+00 0.0000E+00 0.0000E+00 0.0000E+00 0.0000E+00 0.0000E+00
0.0000E+00 0.0000E+00 0.1140E+08 0.6262E+05 0.4550E+07 0.0000E+00
0.0000E+00 0.0000E+00 0.6262E+05 0.2171E+09-0.5623E+05 0.0000E+00
0.0000E+00 0.0000E+00 0.4550E+07-0.5623E+05 0.4993E+10 0.0000E+00
0.0000E+00 0.0000E+00 0.0000E+00 0.0000E+00 0.0000E+00 0.0000E+00
```

However, in other Aqwa output files, the stiffness matrix differs slightly, as displayed in figure 6, as Aqwa linearizes all restoring forces and moments, incorporating them into the stiffness matrix.

STIFFNESS MATRIX						
	X	Y	Z	RX	RY	RZ
X	0.0000E+00	0.0000E+00	0.0000E+00	0.0000E+00	0.0000E+00	0.0000E+00
Y	0.0000E+00	0.0000E+00	0.0000E+00	0.0000E+00	0.0000E+00	0.0000E+00
Z	0.0000E+00	0.0000E+00	1.1398E+07	-6.2619E+04	4.5499E+06	0.0000E+00
RX	0.0000E+00	0.0000E+00	-6.2619E+04	1.0841E+08	3.1230E+04	-2.2678E+07
RY	0.0000E+00	0.0000E+00	4.5499E+06	3.1230E+04	4.8863E+09	2.6343E+05
RZ	0.0000E+00	0.0000E+00	0.0000E+00	0.0000E+00	0.0000E+00	0.0000E+00

Fig.6: Hydrostatic stiffness matrix in the Aqwa result.

4.3 Buoyancy reference parameters

The buoyancy reference parameters required by MCOL are significantly influenced by the vessel's defined position relative to the waterplane in Aqwa. These parameters are primarily calculated by Aqwa, and the relevant data from the *.MCO file of the model ship is shown below.

```
004$buoyancy parameters (xb,yb,zb,W=m*g,B=rho*g*displ,ZOGref,PHIref,TETAref)
0.4441E+00-0.1330E-03 0.2125E+01 0.5113E+08 0.5113E+08 0.0000E+00
0.0000E+00 0.0000E+00
```

4.4 Added mass matrix

As previously mentioned, the MCOL coordinate system differs by 180 degrees about the Aqwa global x-axis. Consequently, when exporting data for MCOL, the added mass matrix at infinite frequency from Aqwa is transformed to align with the MCOL coordinate system in the *.MCO file. The added mass matrix at infinite frequency of the case study ship is provided below.

```
005$added mass matrix (Ma)
0.1498E+06 0.7803E+02-0.3067E+05 0.5467E+04-0.1095E+08 0.8665E+04
-0.2560E+02 0.1545E+07 0.5286E+03 0.5733E+06 0.4231E+04 0.6533E+07
-0.3166E+05 0.5233E+03 0.7314E+07 0.2747E+05 0.1324E+07 0.3612E+03
0.3026E+04 0.5943E+06 0.3178E+05 0.4096E+08-0.2180E+06-0.1087E+08
-0.1096E+08-0.7660E+04 0.1350E+07-0.4076E+06 0.1914E+10-0.6508E+06
0.8812E+04 0.6535E+07-0.5356E+04-0.1037E+08-0.6927E+06 0.7355E+09
```

Comparing this matrix with the added mass matrix at infinite frequency from another Aqwa output file, shown below, we can observe sign differences caused by the coordinate system transformation.

```
0.1498E+06 -0.7794E+02 0.3067E+05 0.5467E+04 0.1095E+08 -0.8663E+04
0.2559E+02 0.1545E+07 0.5286E+03 -0.5733E+06 0.4229E+04 0.6533E+07
0.3166E+05 0.5231E+03 0.7314E+07 -0.2747E+05 0.1324E+07 0.3703E+03
0.3026E+04 -0.5943E+06 -0.3178E+05 0.4096E+08 0.2180E+06 0.1087E+08
0.1096E+08 -0.7652E+04 0.1350E+07 0.4076E+06 0.1914E+10 -0.6505E+06
-0.8814E+04 0.6535E+07 -0.5359E+04 0.1037E+08 -0.6928E+06 0.7355E+09
```

4.5 Wave damping matrixes

Wave damping matrices are calculated and output at various frequency points. Aqwa diffraction analysis includes up to 100 frequency points, which exceeds the 60-point limit of the MCOL solver. As a diffraction and radiation solver, Aqwa computes wave damping matrices across all frequency points. Figure 7 illustrates the six diagonal radiation damping values over the encounter frequency range for the model vessel, where the expected decay at higher frequencies is observed. Similar to the transformation of the added mass matrix, all damping values in the *.MCO file have been converted to match the MCOL solver's coordinate system. Due to the extensive length of the data, these values are omitted from this paper.

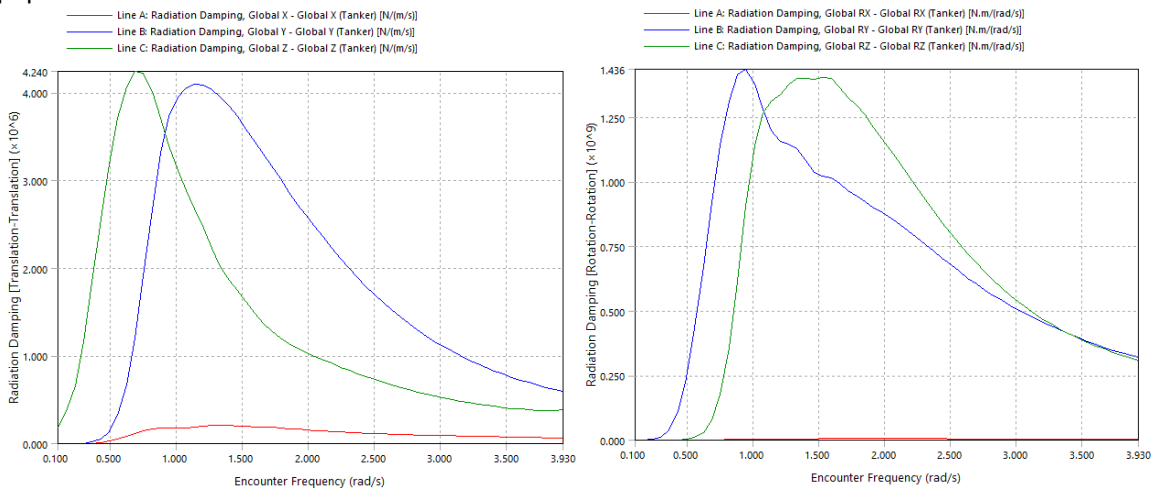

Fig. 7: Radiation damping curves for six diagonal elements across the encounter frequency range.

5 Examples

The two examples are investigated in this paper, one is collision model, and another is grounding model. In each example, there are 5 cases studied, purely FEM model, and LS-DYNA/MCOL with different partition part of the ship as shown in figure 8-12. The material model of ship is ***MAT_PIECEWISE_LINEAR_PLASTICITY** for both examples.

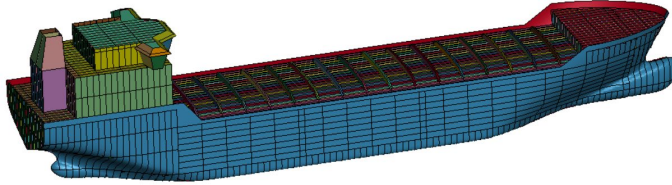

Fig.8: Case 1 purely FEM model of ship

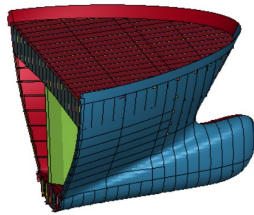

Fig.9: Case 2 the MCOL deformable partition is 16% of ship

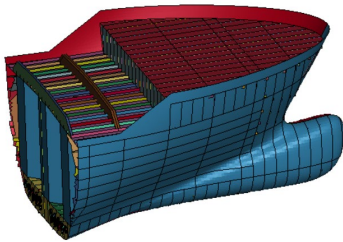

Fig.10: Case 3 the MCOL deformable partition is 24% of ship

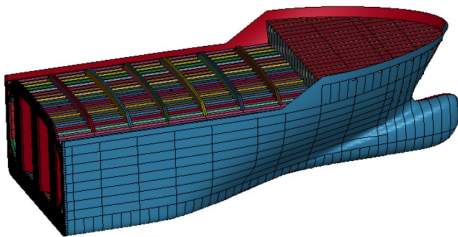

Fig.11: Case 4 the MCOL deformable partition 42% of ship

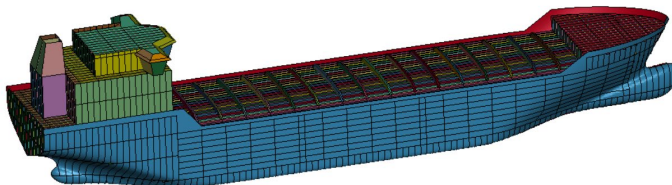

Fig.12: Case 5 the MCOL deformable partition is 100% of ship

5.1 Collision model

The figure 13 shows the collision example, the pole is modelled by ***MAT_PLASTIC_KINEMATIC** in this example. Figure 14 is location for element 257579 and node 237929. Figure 15-17 are comparison of the X velocity for node 237929, Von Mises stress and plastic strain for element 257579. Figure 18 is

contour plot of Von Mises stress for 5 different cases. The table 3 is the CPU time comparison for each case. From these results, one can see that case 2, 3 and 4 results look similar, case1 and 5 are not good. The reason is that the pure FEM model (case 1) does not consider coupling affect between structure and water, which cannot be neglected, and based on MCOL theory that the structure dynamic equation does not include the added mass/damping/hydrodynamic force. Using whole ship as deformable part for the structural dynamic response may not be good idea. The small partition gives good results and less CPU time since partial ship needs to be meshed as deformable part.

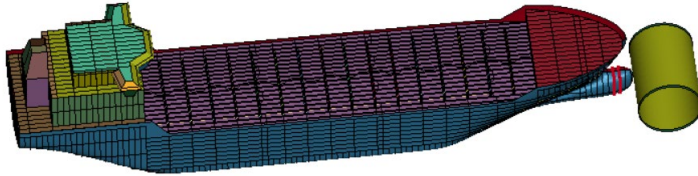

Fig.13: LS-DYNA/MCOL collision model

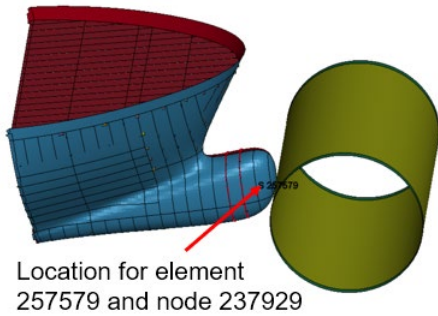

Fig.14: Location for element 257579 and node 237929

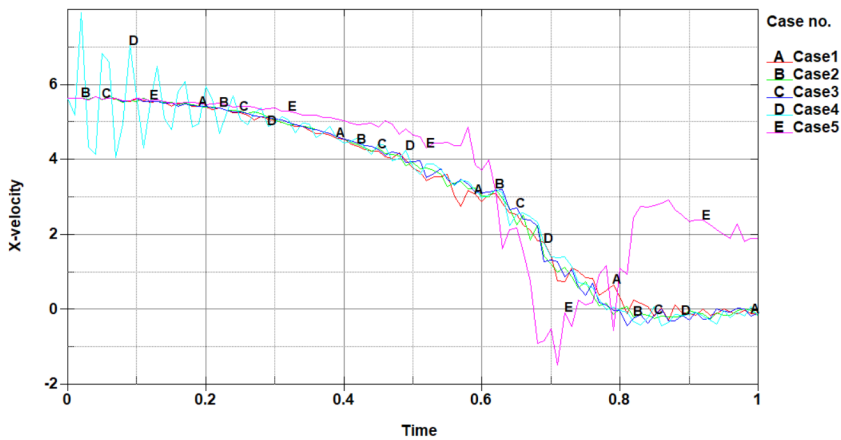

Fig.15: X velocity of the node 237929 for different cases

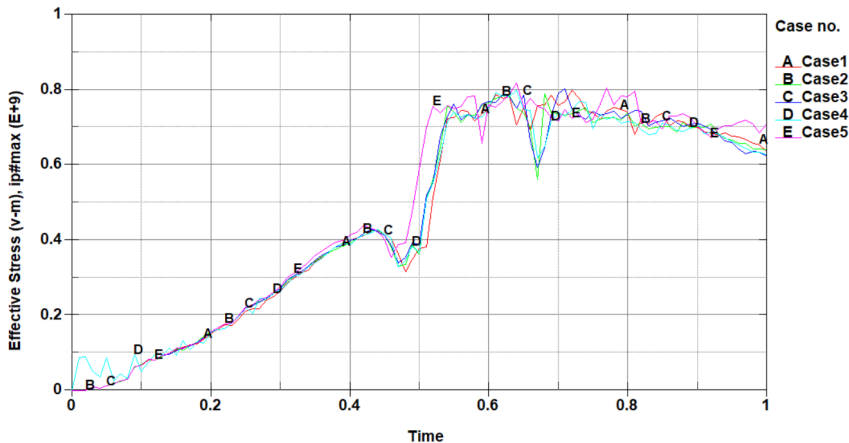

Fig.16 The Von Mises of element 257579 for different cases

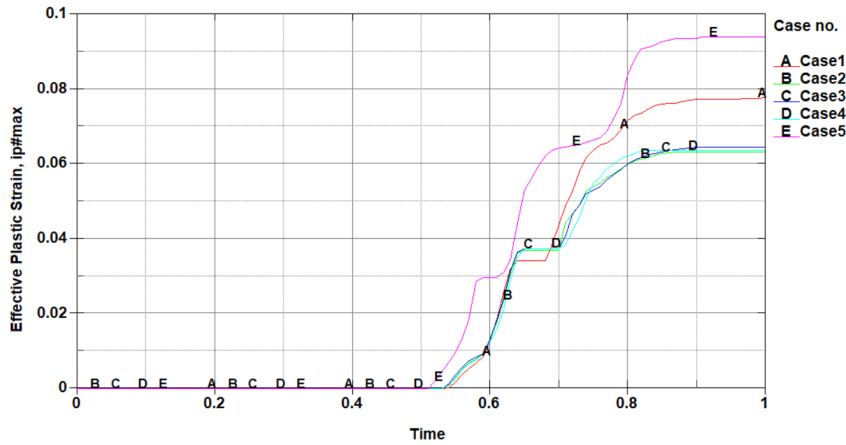
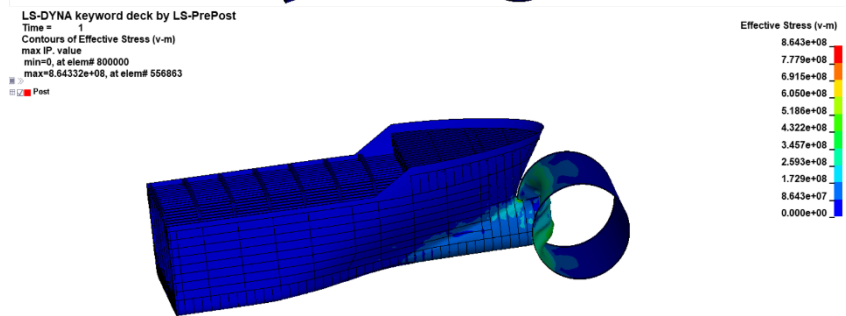
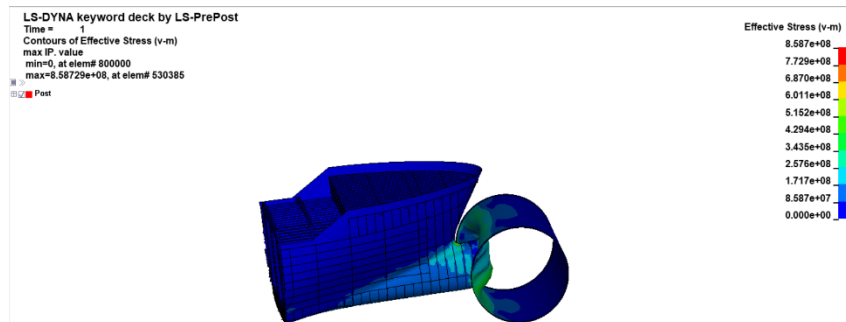
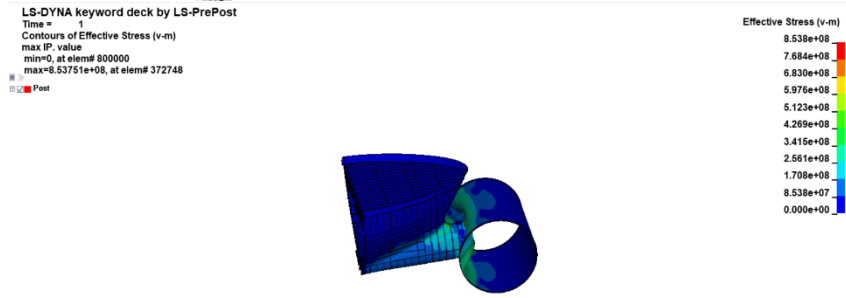
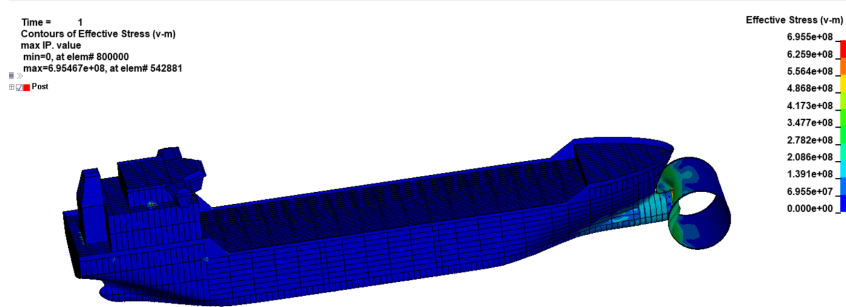

Fig.17: The plastic strain of element 257579 for different cases



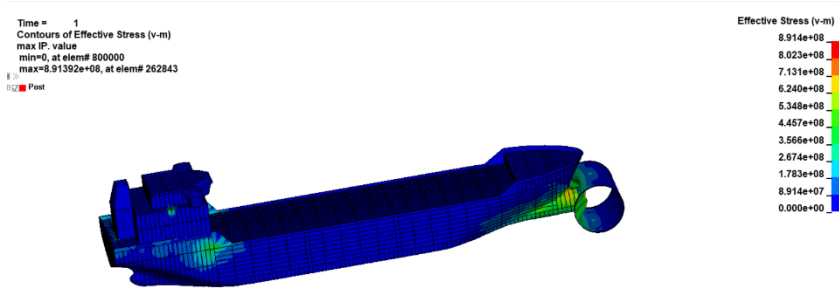

Fig.18: The contour plot of Von Mises stress results for 5 different cases

Model	CPU time (MPP with 96 processors)
Case1: pure FEM	2149s
Case2: FEM/MCOL	741s
Case3: FEM/MCOL	818s
Case4: FEM/MCOL	1078s
Case5: FEM/MCOL	2361s

Table 3: CPU time comparison

5.2 Grounding model

The figure 19 shows the collision example and ***MAT_RIGID** is used to model rock for grounding sample, Figure 20 is location for element 257579 and node 237929. Figure 21-23 are comparison of the X velocity for node 223146, Von Mises stress and plastic strain for element 251949. Figure 24 is contour plot of Von Mises stress for 5 different cases. The table 4 is the CPU time comparison for each case. Like collision model, from these results, one can see that case 2, 3 and 4 results look good, case1 and 5 are not good. One can use small partition to get better results and less CPU time.

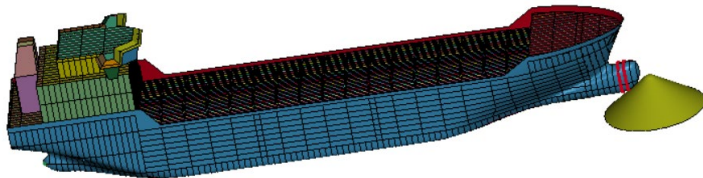

Fig.19: The LS-DYNA/MCOL grounding model

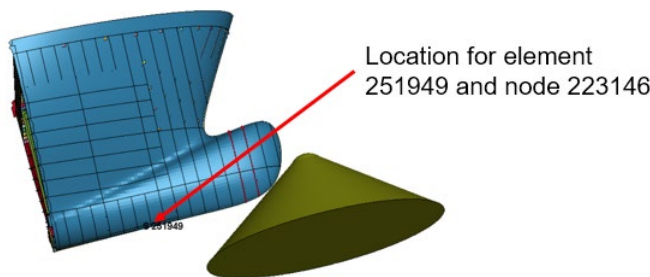

Fig.20: Location for element 251949 and node 223146

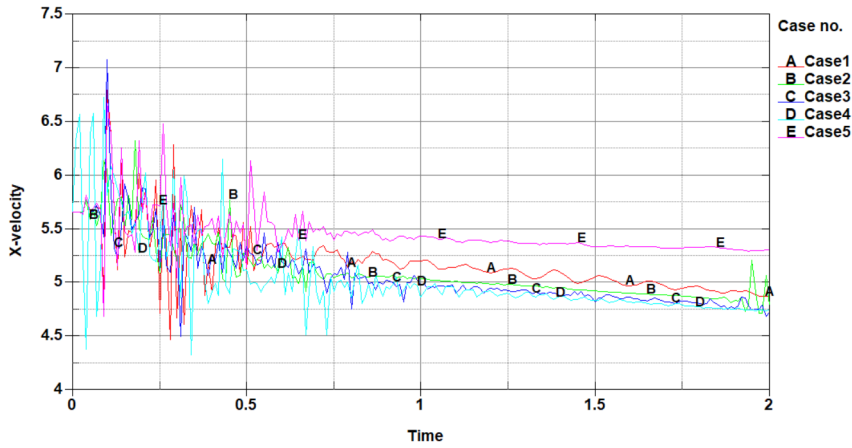

Fig.21: X velocity for the node 223146

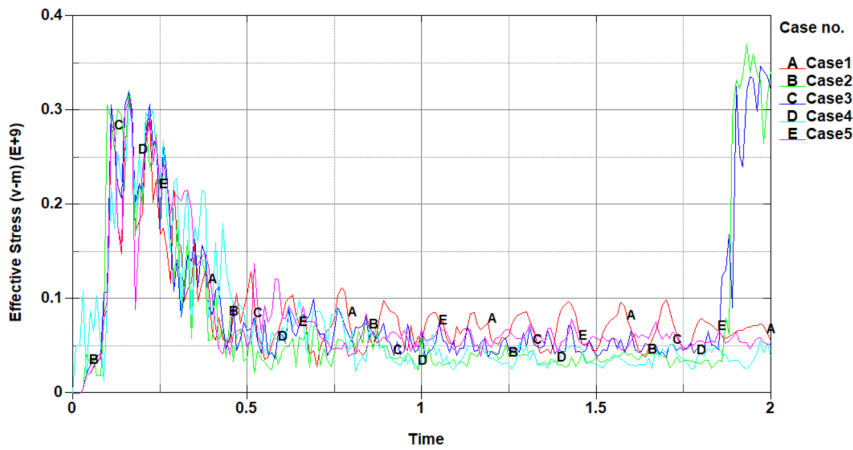

Fig.22: The Von Mises stress of element 251949 for different cases

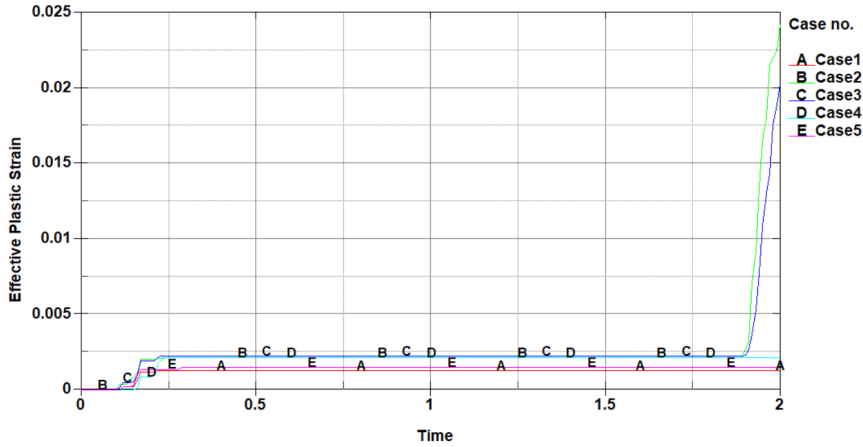
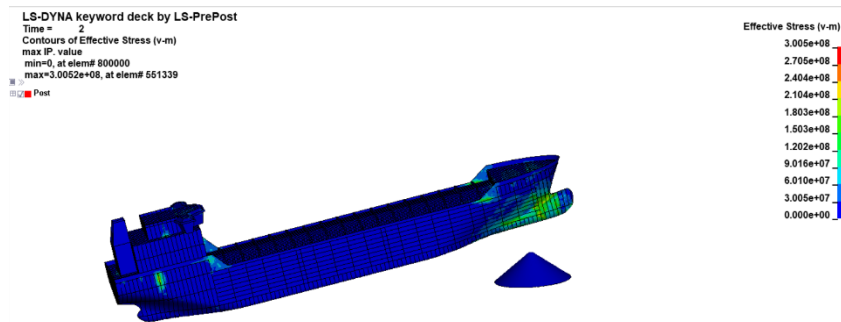

Fig.23: The plastic strain of element 251949 for different cases



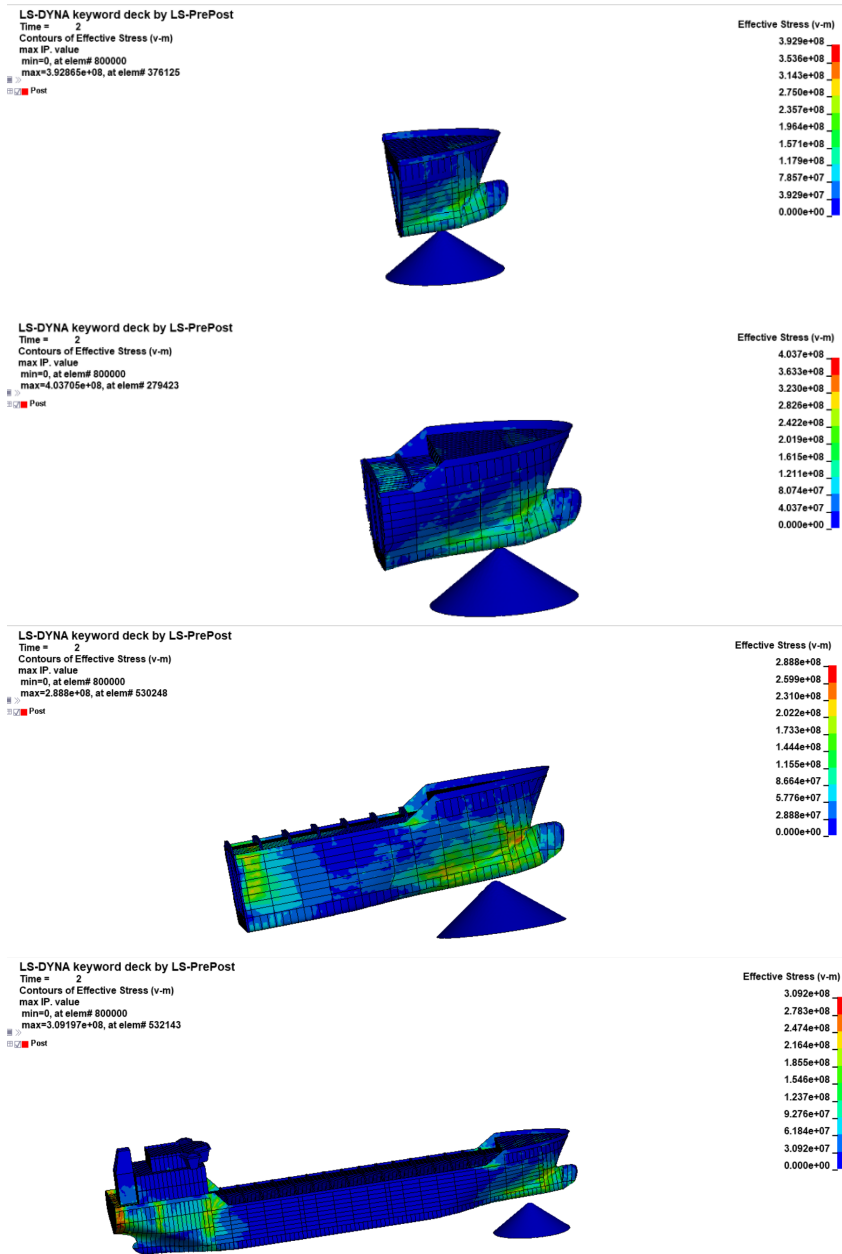

Fig.24: The contour plot of Von Mises stress results for 5 different cases

Model	CPU time (MPP with 96 processors)
Case1: pure FEM	7507s
Case2: FEM/MCOL	1639s
Case3: FEM/MCOL	2369s
Case4: FEM/MCOL	3181s
Case5: FEM/MCOL	7614s

Table 4: CPU time comparison

6 Summary

This paper presents the workflow of LS-DYNA/MCOL-Aqwa coupling analysis and introduces the necessary keywords to drive this solution. Because MCOL solver requires data such as hydrostatic restoring matrix, the added mass matrix and the frequency dependent added damping matrices etc. for each ship provided by the third-party code previously, users need use different software products to do ship collision and grounding analysis. Now, Aqwa has the capability to generate these parameters, the whole workflow can be done by Ansys products.

Some examples are included for the purpose of illustration and validation.

7 Literature

- [1] Pedersen M.J., "Dynamics of Ship Collisions", Ocean Engineering 9:2,1982, pp.295-329
- [2] Pedersen P.T., "Collision and Grounding Mechanics", Proceedings of WEMT'95, 1995, pp.125-157
- [3] Hervé Le Sourne, Nicolas Couty, François Besnie, Cyrille Kammerer**, Hervé Legavre, "4th European LS-DYNA Users Conference", 2003
- [4] [LS-DY-NA® R15 Keyword Manual Vol I](#)
- [5] [Ansys Aqwa theory manual, 2024R2](#)