

Trimmed IGA B-Spline Solids VS. Standard Tetrahedra Finite Elements

Stefan Hartmann¹, Lukas Leidinger¹, Frank Bauer²,
Dave Benson³, Attila Nagy³, Liping Li³, Marco Pigazzini³, Lam Nguyen³

¹DYNAmore GmbH, an ANSYS company
Industriestr. 2, 70565 Stuttgart, Germany

²BMW Group
Knorrstraße 147, 80788 Munich, Germany

³ANSYS
7374 Las Positas Road, Livermore, CA 95411, USA

1 Introduction

In 2005, Hughes et al. [1] introduced isogeometric analysis (IGA). As opposed to standard Lagrange polynomial-based finite element analysis (FEA), IGA utilizes the same shape functions employed in computer-aided design (CAD) for numerical analysis. In the last decade, the development of IGA in LS-DYNA was mainly focused on thin-walled structures modelled as either structured trimmed or unstructured isogeometric shells. Currently, there is growing interest in the analysis of more complex engineering parts. This requires the use of accurate solid finite elements. It is well known however that rather poor computational performance can be achieved by invoking low-order solid elements. Recently, the potential benefits of volumetric B-spline finite elements have been successfully demonstrated by Meßmer et al. [2], [3]. This led to an increased customer interest and thus to the development of trimmed isogeometric solids in LS-DYNA. This paper provides an overview of basic concepts and current capabilities of trimmed isogeometric solids in LS-DYNA.

The structure of the remaining part of the paper is organized as follows. Section 2 conveys the main ideas of trimmed isogeometric solids. The influence of trimming higher degree B-spline basis functions on the stable time step size is explored in Section 3. Selected numerical examples are shown to compare the performance of the trimmed isogeometric solids with respect to standard linear tetrahedra finite elements in Section 4. Finally, some conclusions and an outlook on future developments are given in Section 5.

2 Basics of trimmed isogeometric solids

2.1 Motivation

A few examples of typical volumetric engineering parts are shown in Fig.1. These structures cannot be classified as thin-walled and thus the use of volumetric discretization is imperative. Considering complex geometries, the current state of the art numerical analysis relies on the use of low-order finite elements, e.g., linear tetrahedrons, known for their rather poor performance. The complexity of the parts directly effects the maximum element size needed to approximate the geometry within reasonable tolerance. The smallest element size in a finite element model also dictates the maximum stable time step size in explicit dynamics. A small stable time step combined with a large number of small tetrahedra elements typically makes the computational effort insurmountable and consequently limits the applicability of the approach. Trimmed isogeometric solids may represent a sound solution to this problem.

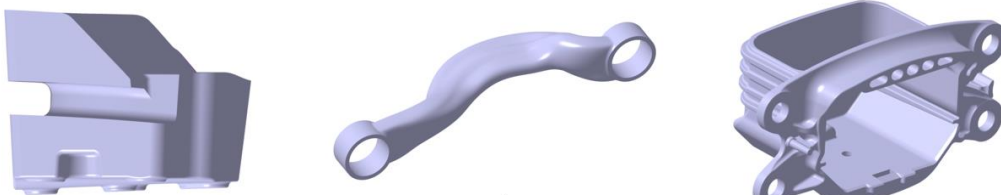

Courtesy of BMW Group

Fig.1: Volumetric engineering components: CAD models [4].

2.2 Embedding approach

The main idea of trimmed isogeometric solids is very similar to immersed or embedded methods. The boundary representation of the structure is embedded in the parametric space of a trivariate B-spline. The parameterization given by the knot vectors yields a regular structured mesh, commonly referred to as the background grid, see Fig.2. If the B-spline is not trimmed, the resulting non-zero knot spans are considered as finite elements. Trimming slightly complicates the matter as one may distinguish between fully embedded (untrimmed), partly embedded (trimmed), and not embedded (inactive) knot spans. Only fully and partially embedded non-zero knot spans play the role of elements in trimmed isogeometric analysis. Untrimmed elements are treated in a standard manner using standard numerical integration rules. Trimmed elements highlighted in red in the right image of Fig.2., need to be treated in a special manner as described in the next section.

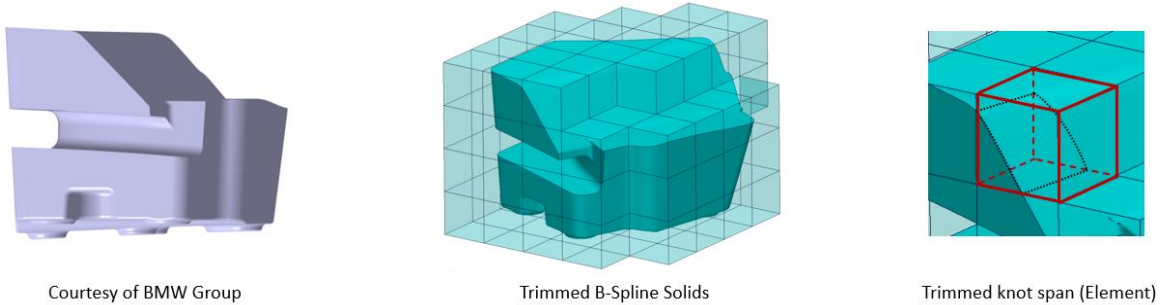

Fig.2: Embedding of the geometry into a hexahedron B-Spline background grid [4].

2.3 Numerical integration of trimmed knot spans

One of the most important and challenging aspects of the development of trimmed isogeometric solids is the definition of a suitable numerical integration scheme for trimmed elements. This topic was explored in depth in collaboration with the Technical University of Munich and the interested reader is referred to the papers by Meßmer et al. [2], [3]. A suitable numerical integration scheme for trimmed elements fulfills the following requirements:

- Integration points shall only be placed within the material domain, as the material law is usually evaluated at the integration points.
- Integration weights shall be positive.
- The numerical scheme must be accurate. Simply put, the rule should be able to integrate all required polynomials within a predefined tolerance with as few integration points as possible for an efficient, fast, and stable computation.
- The quadrature design shall be applicable for arbitrarily shaped trimmed domains.

Quadrature design for the trimmed solid elements in LS-DYNA is performed using an approach like the one described in [3] which can be seen as an extension of the numerical integration of trimmed isogeometric shells [5] to three dimensions. To generate a suitable numerical integration scheme on a trimmed domain, first an adequately selected set of functions are accurately integrated over the boundary of the domain using the divergence theorem. This represents the desired solution, i.e., the constant term in the moment-fitting equations. Next, a large enough number of integration points are initialized within the material domain of the trimmed element. Finally, the moment fitting equations are solved using a non-negative least square solver to eliminate unnecessary integration points. The resulting integration points and weights can numerically integrate the desired functions up to machine precision. Some trimmed domains with the generated integrations points are shown in Fig. 3.

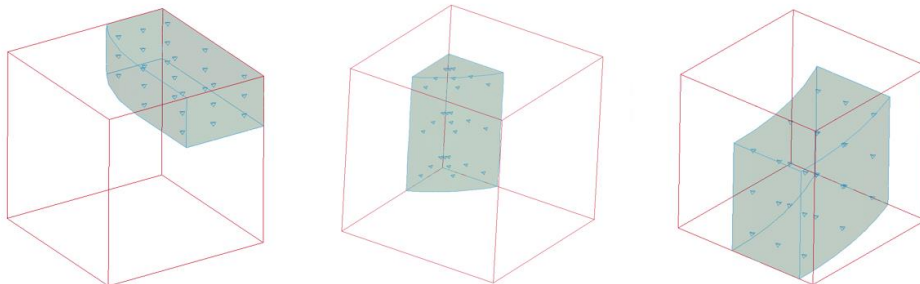

Fig.3: Selected trimmed elements with integration points.

2.4 Geometry and mechanics

It is worth highlighting that the accuracy of the geometric representation is independent of the parameterization of the trivariate B-spline and hence the discretization invoked for analysis. The accuracy of the solution depends solely on the parameterization of the volume, i.e., the knot vector and the polynomial degree in each parametric direction. As an example, Fig. 4 shows a crash pad model with a relatively coarse background discretization and an accurate geometric representation.

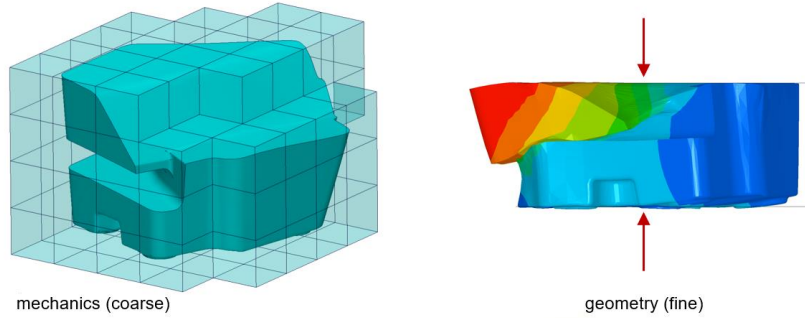

Fig.4: Decoupling of geometry and mechanics.

3 The effect of trimming on the critical time step size

In this section the effect of trimming on the critical time step size for explicit dynamics is reviewed. The study was originally performed in Meßmer et al. [2] and the main results are recapitulated here. For the study a trivariate B-Spline solid cube with varying degree ($p = 1$ to 4) and maximum C^{p-1} inter-element continuity was constructed. The cube had an edge length of 120mm and was parametrized using identical uniform knot vectors in each parametric direction resulting in a total of 12x12x12 knot spans each with the dimension of 10x10x10mm. To analyze the effect of trimming, the B-spline was trimmed from all sides with a distance $\hat{\theta}$, varying from 0mm to 40mm, see Fig.5. Once the trimming distance hits 10, 20, 30 and 40mm, another full knot span will be trimmed away in each direction.

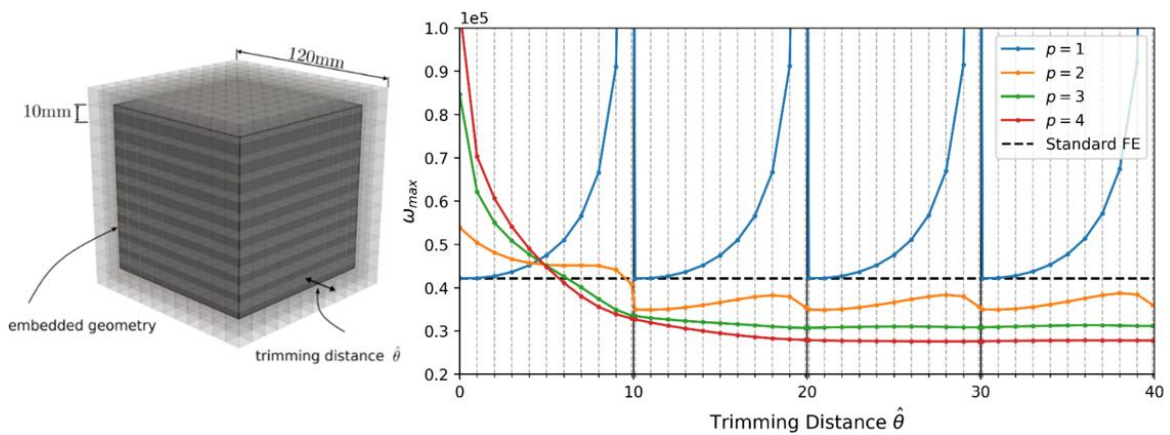

Fig.5: Trimmed B-spline cube (left), max. eigenfrequency as a function of trimming distance (right) [2].

It is well known that the critical time step size is proportional to the maximum eigenfrequency (ω_{max}) of the structure, i.e. $\Delta t_{crit} = 2/\omega_{max}$. Notably, the row-sum lumped mass matrix was used to extract the maximum eigenfrequencies in this study. The maximum eigenfrequency of the B-spline solid as a function of the trimming distance is shown in Fig.5. The black dashed line indicates the maximum eigenfrequency computed for the untrimmed cube with standard linear finite elements. The blue curve represents the behavior for $p = 1$, which means for standard linear shape functions with C^0 continuity. Whenever the trimming distance approaches the next knot span, the eigenfrequency tends to infinity resulting in an infeasible stable time step size that tends to zero. However, once the polynomial degree is increased together with the continuity, ω_{max} is bounded and basically drops below the initial untrimmed FE solution once the first knot span is fully trimmed away. This positive effect on the critical time step size for trimmed elements was already studied in detail for isogeometric shell elements by

Leidinger [6] and is mainly due to the use of higher continuity basis functions. In short, the use of higher order and higher continuity basis functions is especially well-suited to perform explicit dynamic simulations. Thus, with a lumped mass matrix trimming of the knot span does not adversely influence the critical time step size. With the background of isogeometric analysis, the choice of using B-spline basis functions is therefore quite natural.

4 Numerical examples

In this section four different numerical models are analyzed to compare the performance of trimmed isogeometric solids with respect to their linear finite element counterparts.

4.1 Extruded profile

The first example is an extruded profile of about 800mm length. The profile is impacted by a rigid cylinder as shown in Fig.6. The cross-section dimensions are about 200mm in width and 72mm in height. An elasto-plastic material law without failure evaluation was chosen. Five different discretizations were analyzed as depicted in Fig.7. Boundary conditions and contact settings are identical between the different models.

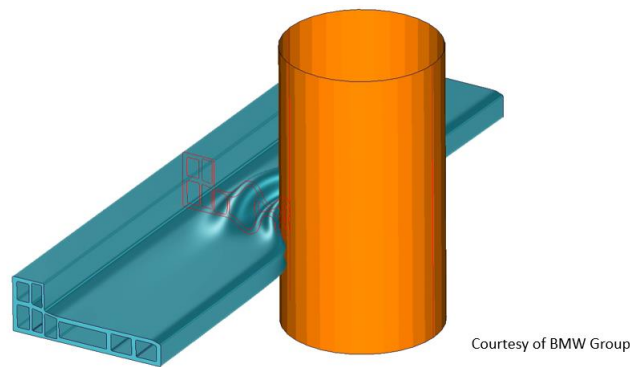

Fig.6: Impact of rigid cylinder on the extruded profile.

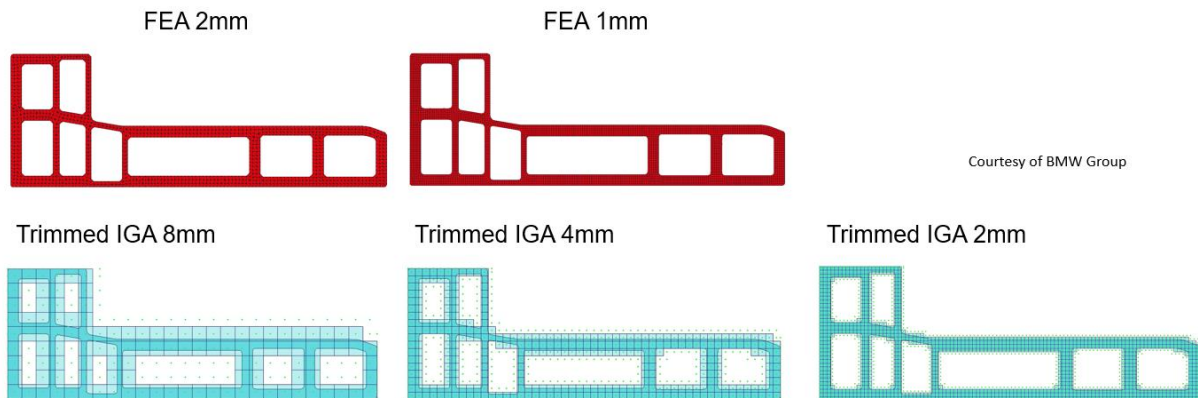

Fig.7: Discretizations used in the study.

The evaluated total contact force is shown in Fig.8. It can be seen that with the trimmed IGA solids, a similar behavior can be achieved with element sizes that were about twice as big. IGA 4mm relates well with FEA 2mm and IGA 2mm correlates well with FEA 1mm. This is also reflected in the local buckling behavior which is shown for FEA 1mm and IGA 2mm discretization in Fig.9. At this point, no detailed comparisons in terms of necessary CPU time are performed but it is expected that this information can be shared during the actual presentation of the paper at the conference.

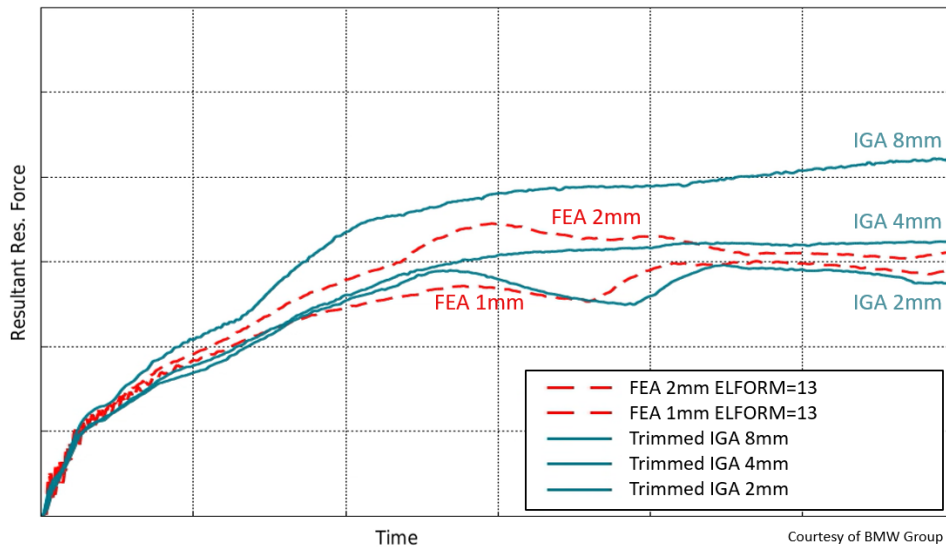

Fig.8: Total resultant contact force-time chart for rigid cylinder impact.

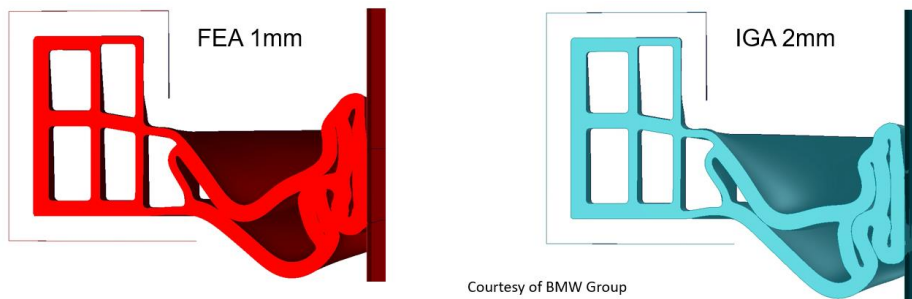

Fig.9: Local buckling pattern of the cross-section in the center of the profile.

4.2 Wishbone

The second model is a 3-point-bending test of a wishbone. Again, an elasto-plastic material behavior is used and, as before, five different discretizations are compared as shown in Fig.10. All the models show comparable results which can be seen in the final deformed configuration as depicted in Fig.11. Looking at the total resultant force vs. time plot shown in Fig.12 underlines the comparable behavior of all five different models.

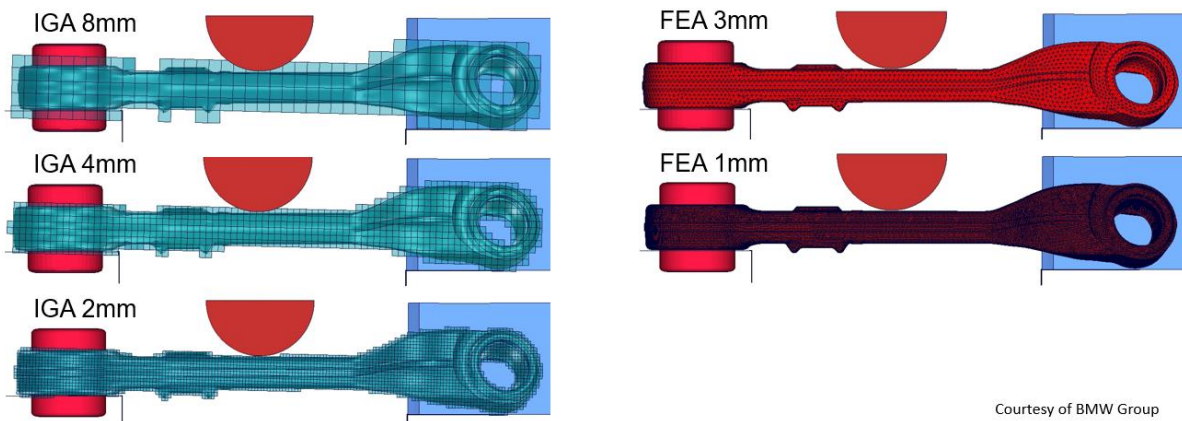

Fig.10: Different discretizations used for the wishbone model

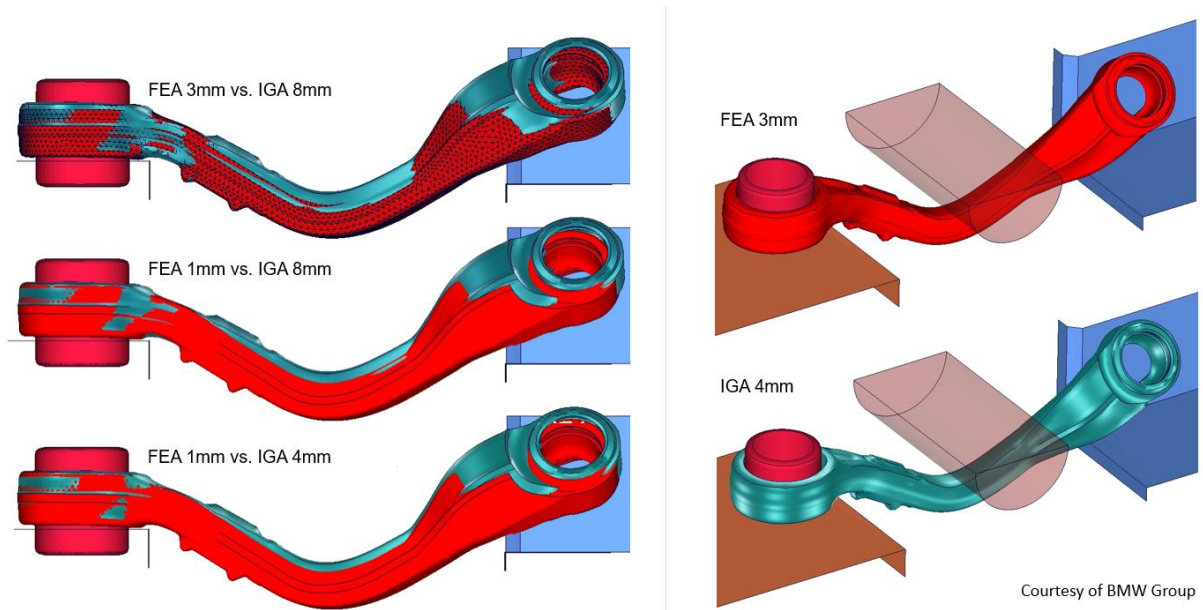

Fig.11: Deformed configuration at the end of the simulation

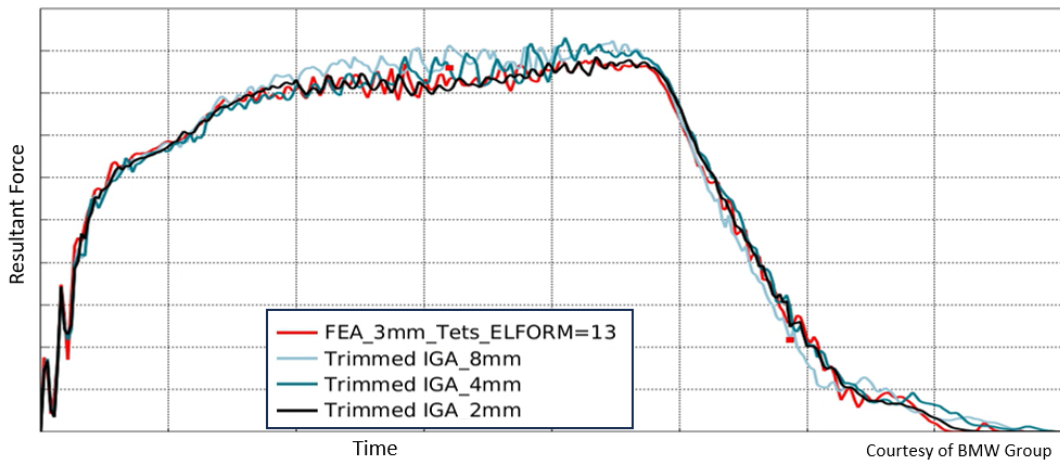

Fig.12: Resultant force vs. time

| Model | time step (dt0, used) | added mass | added mass ratio | solved on | CPU time |
|---------------------|-----------------------|------------|------------------|------------------|-------------------------------|
| FEA 3mm (ELFORM=13) | 1.80E-07 | 1.0433E-05 | 2.05% | 12 CPUs, local | 54 min 19 seconds |
| FEA 1mm (ELFORM=13) | 1.80E-07 | 2.3102E-03 | 455% | 48 CPUs, cluster | 2 hours 46 minutes 57 seconds |
| IGA 8mm | 1.29E-06 | 0 | 0 | 12 CPUs, local | 0 hour 6 minutes 12 seconds |
| IGA 4mm | 6.47E-07 | 0 | 0 | 12 CPUs, local | 0 hour 16 minutes 51 seconds |
| IGA 2mm | 3.18E-07 | 0 | 0 | 48 CPUs, cluster | 1 hour 15 minutes 40 seconds |

Fig.13: Performance comparison

While all the models seem to give similarly good results, it is worth looking at the performance in terms of computational time, see the table which compares various metrics in Fig.13. The two FE models were run with a predefined time step size of 1.8E-7s. Looking at the non-zero added mass (ratio) in the table, the initial stable time step size would have been smaller for FE models. While the 2% added mass is tolerable in case of the larger 3mm FE model, over four times the original mass had to be added to the 1mm FE model to perform a stable computation with the prescribed time step size. In contrast, no

predefined time step was set, and hence no mass scaling was performed in the case of the isogeometric models. More importantly, the stable time step size for all three isogeometric models was larger than the one preset value used for the FE computations. This leads to significantly faster solving time. While the 3mm FEA model needs about 54min to complete on 12 CPUs, the 4mm IGA model needs about 16min and the 8mm IGA model only 6min. Considering the two finest models, run on a cluster with 48 CPUs, the 2mm isogeometric model is more than twice as fast as the 1mm finite element model with unacceptably high mass scaling. The coarsest trimmed isogeometric model gives reasonably good results without any discretization errors of the embedded geometry highlighting the potential of trimmed isogeometric solids.

4.3 Academic Cast Component

This academic cast component serves as an additional example to demonstrate the benefits of trimmed isogeometric solids for parts with relatively fine ribs. A representative geometry of the model and the utilized boundary conditions are shown in Fig. 14.

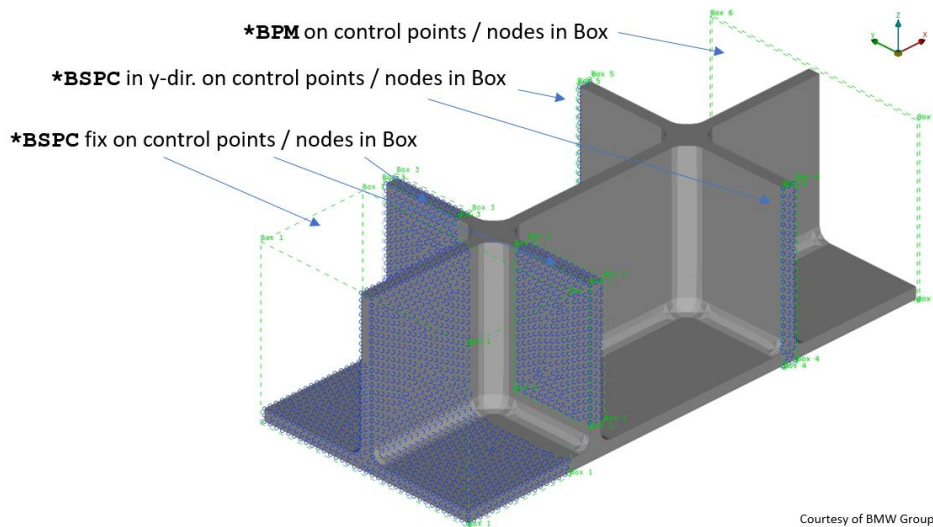

Courtesy of BMW Group

Fig.14: Geometry and boundary conditions of the academic cast component

The geometry consists of a base plate that is stiffened with one longitudinal and two perpendicular ribs. Various rib thicknesses have been studied but the results are restricted to a 2mm thick rib in this paper. The boundary conditions are applied utilizing `*DEFINE_BOX` definitions, see Fig. 14, together with `*BOUNDARY_SPC` (`*BSPC`) and `*BOUNDARY_PRESCRIBED_MOTION` (`*BPM`), as a more sophisticated application of boundary conditions was not available for the trimmed solids in LS-DYNA at the time of this study. For a comparative study, the cast component was also modeled with standard linear tetrahedra. For the FE model, 1-point integrated tetrahedra elements (ELFORM=13) are used with average mesh sizes of 0.5mm, 1.0mm and 2.0mm. For the trimmed IGA solids, a triquadratic B-spline background grid is used with knot span sizes of 2.0mm, 4.0mm and 8.0mm.

IGA 2mm

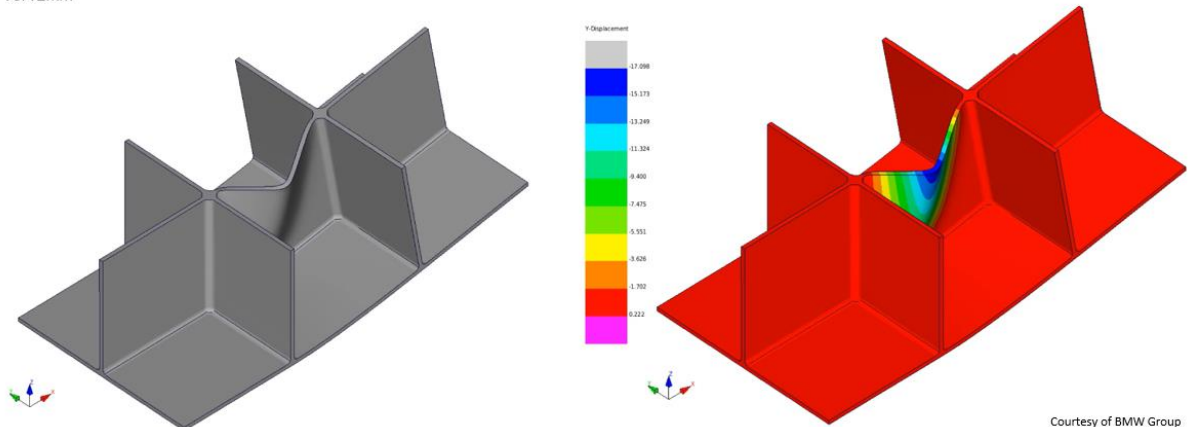

Courtesy of BMW Group

Fig.15: Final deformation of the cast component, using 2.0mm trimmed triquadratic B-Spline solids.

The final deformation of the cast part discretized by 2mm isogeometric elements is shown in Fig. 15. The buckling behavior is well reflected even for this rather coarse discretization.

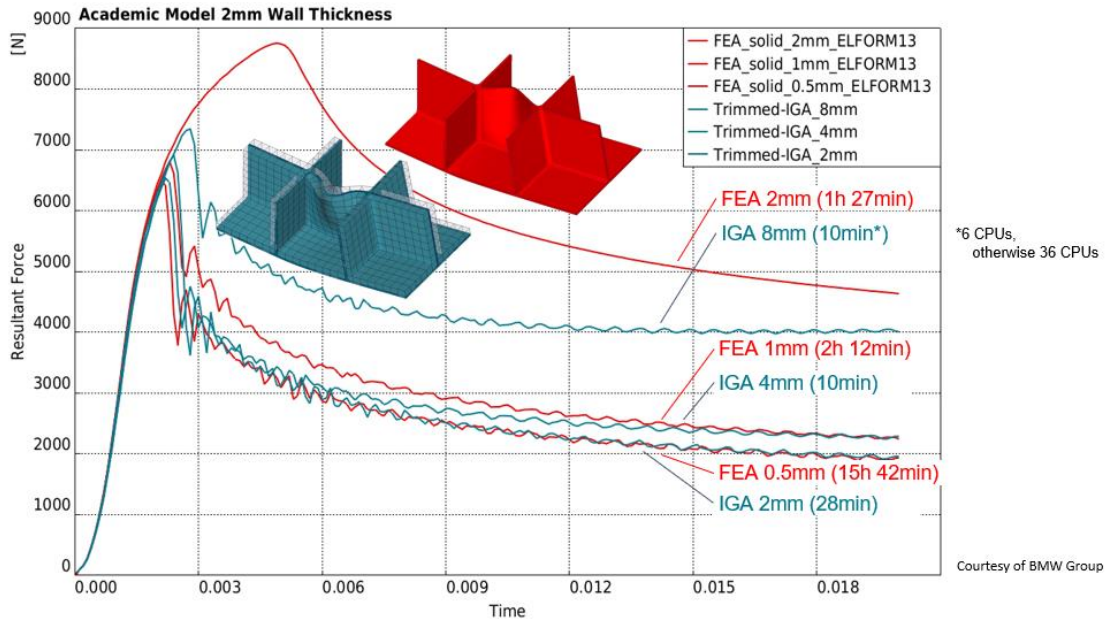

Fig. 16: Resultant force-time plot for different discretizations.

A comparison of the resultant force-time plot for the various models is shown together with some information about the computational time in Fig. 16. The models were run using explicit time integration without mass scaling. Significant differences in the resulting critical time step sizes can be observed. This is also well reflected in the computational time necessary to complete the different runs. Looking at the curves it can be noted that already the coarsest isogeometric discretization with 8.0mm knot span size shows a better behavior than the 2.0mm tetrahedra model. Furthermore, comparable accuracy could be achieved using either FEA 1mm and IGA 4mm or FEA 0.5mm and IGA 2mm, i.e. with a knot span size that is about 4 times the average mesh size of the tetrahedra mesh. With the possibility of using a larger critical time step size this leads to significant reduction of the computational time. While the FEA 0.5mm model needs close to 16 hours to complete on 36 CPUs, the comparable IGA 2mm model finishes in less than 30 minutes using the same number of CPUs.

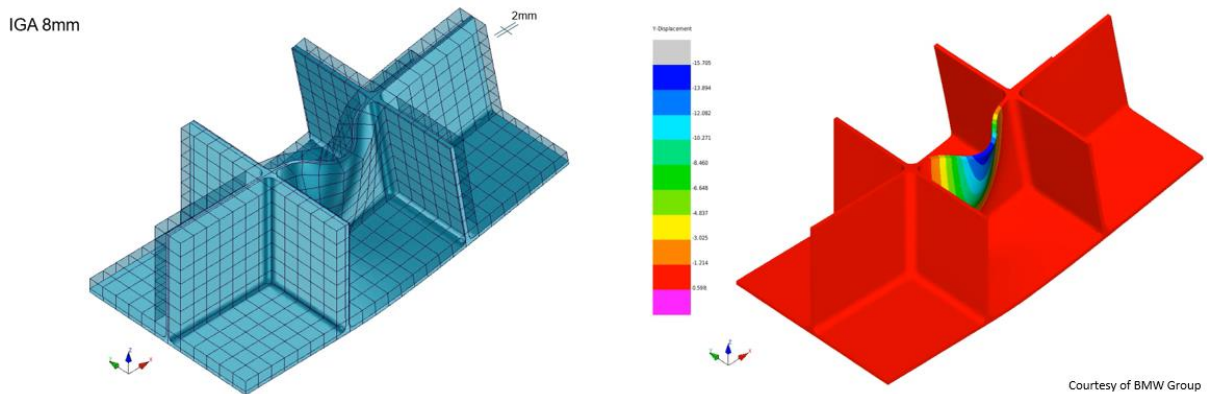

Fig. 17: Final deformation of the cast component using 8.0mm isogeometric solid elements.

The final deformation of the cast component using a knot span size of 8.0mm is shown in Fig. 17. It is worth noting that even this very coarse discretization can capture the buckling behavior reasonably well even though the rib thickness is just 2.0mm. While the maximum possible mesh size using standard finite elements is determined by the rib thickness of 2.0mm, the use of trimmed B-spline solids allows the knot span sizes that are way larger.

4.4 Multipart Assembly

The last example is a rather complex assembly consisting of multiple volumetric parts as shown in Fig. 18. It is a made-up structure that shall showcase the possibility of modeling all the geometric details, like screws and stiffeners while still being able to use a reasonable knot span size in the respective B-spline background grid.

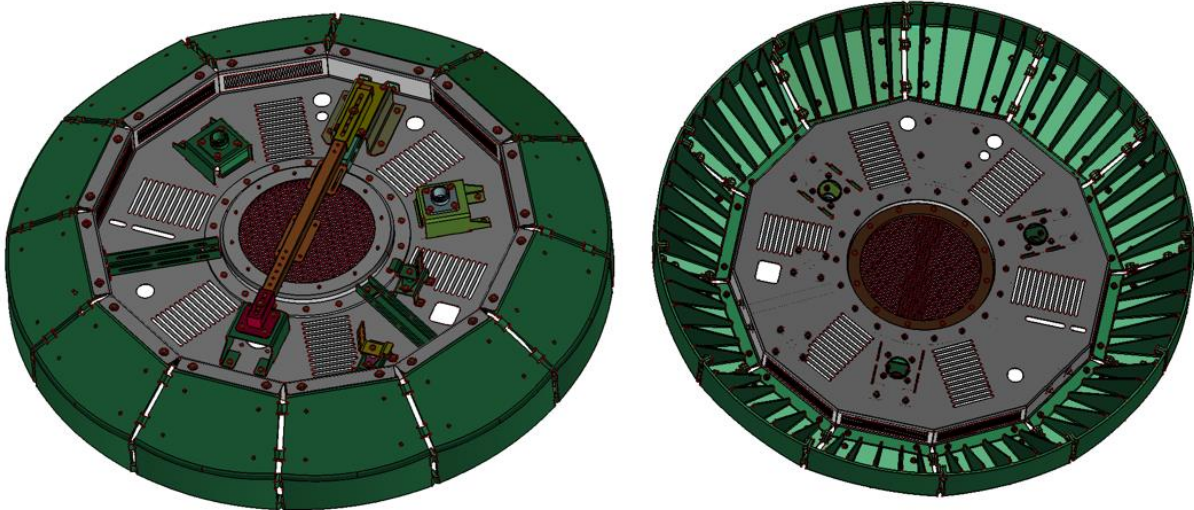

Fig.18: Geometry of the whole assembly.

Each part is individually embedded in a B-spline background grid which is aligned with the respective part geometry, see Fig. 19. The parts are tied together using a penalty-type tied contact (`*CONTACT_TIED_SURFACE_TO_SURFACE_OFFSET`) that acts on the interpolation elements conventionally used in IGA in LS-DYNA.

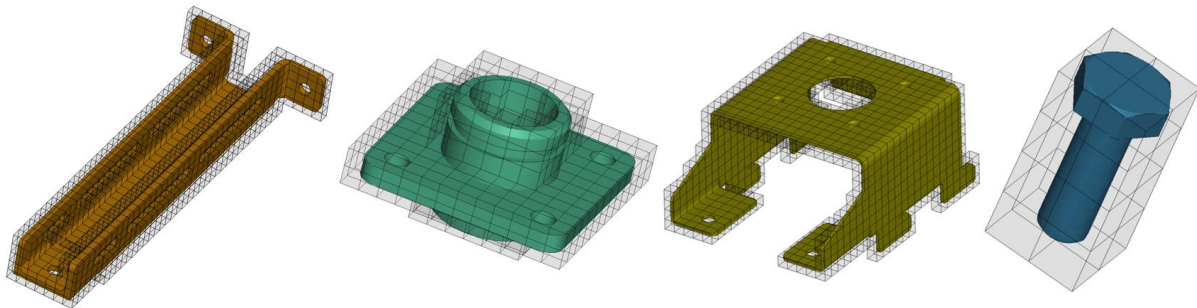

Fig.19: Embedding of selected parts. (Only active knot spans are shown.)

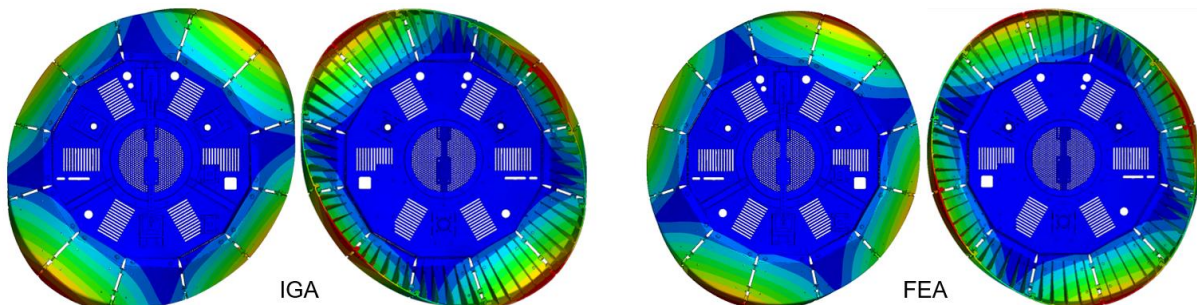

Fig.20: First eigenmode of the whole structure (left: IGA B-splines, right: FEA tetrahedra elements)

To test the proper setup of the model and the connection of the individual parts and eigenvalue analysis of the whole structure has been performed. The first eigenmode of the structure using different discretizations is shown in Fig. 20. Considering the trimmed isogeometric model, uniform background grids with 4.0mm knot span size have been used. To accurately capture the actual geometry with linear tetrahedra, an average element size between 1.0mm and 4.0mm is needed in the different parts. This

again demonstrates the potential to use larger elements with the IGA approach that in turn leads to larger critical time step size and/or less mass scaling in explicit dynamics.

5 Summary and outlook

5.1 Summary

Trimmed isogeometric solids were introduced as an alternative to linear tetrahedra finite elements for the analysis of volumetric parts. The actual geometry of the part is embedded to a background B-spline parameterization. This allows for a decoupling of accurately capturing the actual geometry and the desired accuracy of the mechanical response. Compared to linear finite elements of equal size, it has been shown that the use of B-spline basis functions with higher-order inter-element continuity increases the critical time step size in explicit dynamics. Various examples have been presented that display the potential of this new analysis possibility for volumetric parts.

5.2 Outlook

The work presented here serves as a proof of concept. Although LS-DYNA allows to run these types of models, the generation of such models is still cumbersome and not in a state that is suitable for industrial applications. However, the promising results will help to speed up further developments on both the preprocessing and the solver side. While it is necessary to have easy to use preprocessing capabilities to set up such models, many functionalities, e.g. application of boundary conditions, connection modeling, failure and fracture, etc., still needs to be added to LS-DYNA in order to properly support existing engineering workflows.

6 References

- [1] Hughes, T.J.R., Cottrell, J.A., Bazilevs, Y.: "Isogeometric Analysis: CAD, finite elements, NURBS, exact geometry, and mesh refinement", *Computer Methods in Applied Mechanics and Engineering*, Vol. 194, 2005, 4135-4195.
- [2] Meßmer, M., Leidinger, L., Hartmann, S., Bauer, F., Duddeck, F., Wüchner, R., Bletzinger, K.-U.: "Isogeometric Analysis on Trimmed Solids: A B-Spline-Based Approach focusing on Explicit Dynamics", 13th European LS-DYNA Conference 2021, Ulm, Germany.
- [3] Meßmer, M., Teschemacher, T., Leidinger, L.F., Wüchner, R., Bletzinger, K.-U.: "Efficient CAD-integrated isogeometric analysis of trimmed solids", *Computer Methods in Applied Mechanics and Engineering*, Vol. 400, 2022, 115584.
- [4] Leidinger, L., Hartmann, S., Meßmer, M., Benson, D., Nagy, A., Li, L., Pigazzini, M., Nguyen, L.: "Analysis of 3D structures using IGA solids: Current status and future directions", 16th LS-DYNA Forum 2022, Bamberg, Germany.
- [5] Nagy, A., Benson, D.: "On the numerical integration of trimmed isogeometric elements", *Computer Methods in Applied Mechanics and Engineering*, Vol. 284, 2015, 165-185.
- [6] Leidinger, L.: "Explicit Isogeometric B-Rep Analysis for Nonlinear Dynamic Crash Simulations", PhD thesis, Technical University of Munich, 2020.