

Development of Far-Side Sled Simulation Model with Airbag for Virtual Testing

“Hisaki Sugaya¹”, Yu Kanayama¹, Kanae Matama¹, Nanami Kobayashi², Takashi Kikuchi¹

¹Honda Motor Co., Ltd.

²AutoTechnicJapan co., LTD.

1 Abstract

Currently, Euro NCAP announced a virtual test to improve safety performance robustness. Starting with the Far-side sled test, robustness will be evaluated at different angles and seat positions. Since robustness is evaluated only by simulation, it is crucial to improve the accuracy of the model. Therefore, the objective of this study is to verify the model accuracy level by comparing the simulation with the far-side SLED test with airbag as a benchmark for the virtual test.

In phase 1, the accuracy of the single component models, consisting of the center console and the far-side airbag were verified. The load time history results of the impactor were compared with the simulation.

In phase 2, the accuracy of the far-side SLED model with the far-side airbag was validated by comparing the response characteristics of WorldSID dummy model to be calculated by ISO18571.

In the single component verification, the load time history characteristics of both the center console and the airbag were simulated and reproduced the actual device test well.

In the far-side SLED validation, and the dummy responses of the whole body were scored by ISO18571 with 0.60, 0.58, and 0.73 for the head, spine T4, and Pelvis acceleration, respectively. In terms of the load cell, the upper neck load cell had 0.50 for the force and 0.49 for the moment. Totally the average ISO score for the major accelerometer measurement was 0.64. By reproducing the SLED test by simulation, the average ISO score indicates a reasonable result for reproducing the actual test as the starting point of the virtual test. However, ISO score of the spine T4 is lower than others. It may cause the airbag deployment differences in the simulation. The further investigation items were identified.

***KEYWORDS** “Virtual testing”, “Far-side”.

2 Introduction

In recent years, the number of fatalities from traffic accidents in Japan has been slightly decreasing. [1] Updates to laws and regulations and third-party evaluations are having an effect, but the effect is gradually decreasing nowadays. The fatal accidents may be occurring outside the protocols of laws and regulations, and improving collision robustness as a vehicle safety technology is becoming necessary to reduce the number of fatalities. On the other hand, computer-aided engineering (CAE) has become more popular and standardized to develop the vehicle design. Currently, Euro NCAP has introduced a virtual test to improve robustness safety performance.[2] Starting with the Far-side impact test, robustness will be evaluated at different angles and seat positions. Since robustness is evaluated only by simulation, it is crucial to improve the accuracy of the model.

Therefore, the objective of this study is to verify the model accuracy level by comparing the simulation with an actual SLED test with airbag as a benchmark for the virtual test.

3 Method

A two-phase approach, consisting of the single component model and sled model validation, was taken to achieve our goal with finite element capable software, LS-DYNA (version R9.2.0 LSTC, Livermore, CA, USA). [3] In phase 1, the accuracy of the single component model such as the center console and the far-side airbag were verified. The load time displacement histories of the impactor were compared with each simulation.

In phase 2, the accuracy of the far-side SLED model with the far-side airbag was validated by comparing the response characteristics of the WorldSID dummy model version 7.6.1 produced by DYNAmore with the actual test dummy using ISO18571. [4]

3.1 The single component model validation

The center console impactor model was represented with the quasi-static test as shown in Fig.1. The impact dimension 150mm*200mm was used at impact speed 1mm/sec. The force displacement history was compared with the experimental data and the force data was normalized with the maximum testing force result.



Fig.1: "Center console impact test and model"

The far-side airbag model was evaluated to compare with the experimental head impactor. The impactor simulation was conducted in a lateral direction with a weighing 4.5 kg at a speed of approximately 10 m/s, matching the testing conditions in Fig.2. The airbag model was developed based on the airbag model methodology described by Sugaya et al. [5] Inflator input data was developed to match the tank pressure curve. The simulation result was then conducted considering the force displacement history normalized with the maximum testing force result.

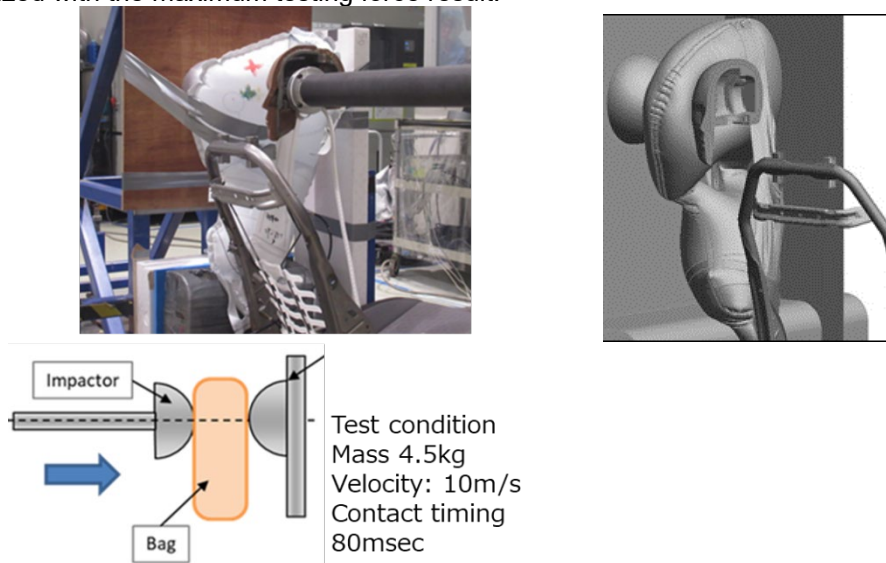

Fig.2: "Far side airbag impactor model".

3.2 The SLED model validation

The far-side impact sled tests with a far-side airbag were simulated using WorldSID model version 7.6.1 produced by DYNAmore in Fig.3. The white body was rigidified and inserted with the center console and far-side airbag developed in phase1. The impact pulses in Fig.4 representing the 32km/h pole impact were applied for the white body. As the restraint system, the belt model was created by 2D element to contact between upper body and seat belt and the seat belt pretensioner was applied by force time history using pretensioner type6 as shown in Fig.5.[6] Initial positions of the WorldSID model was set to match as close to the experimental position coordinate data of each body segment and using landmarks including: head, neck bracket and pelvis hip point.



Fig.3: "Far side sled model".

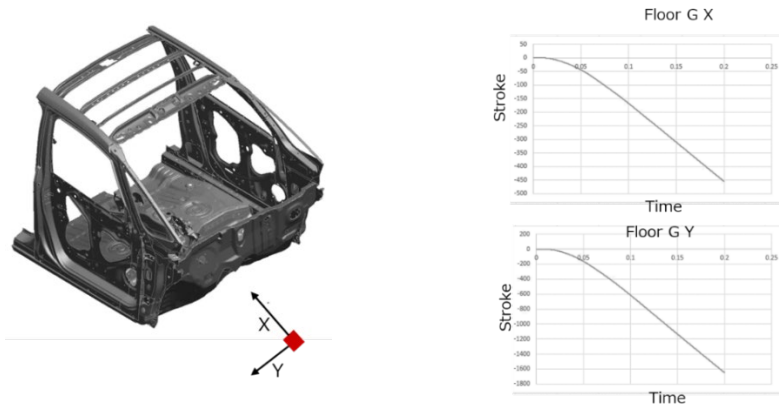

Fig.4: "Far side sled pulse".

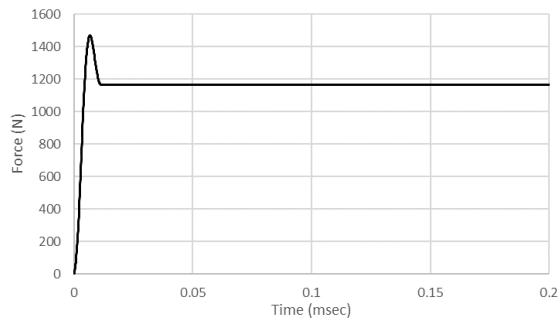

Fig.5: "The seat belt model and pretensioner input model".

Comparisons between the simulation and the test were conducted considering all the following: head, spinal and pelvis accelerations, the neck load cell force and moment time histories. The sled simulation model was then evaluated according to the Euro NCAP Virtual testing protocol. [6] For all sensor locations where more than one axis was measured, weighting factors w_i are calculated for each axis based on the maximum amplitude of each axis in the sled tests according to Equation 1.

$$w_i = \frac{\max(|\text{Channel test}_i|)}{\max(|\text{Channel test}_x|) + \max(|\text{Channel test}_y|) + \max(|\text{Channel test}_z|)} \quad i = x, y, z \quad (1)$$

The weighting factors w_i are then used to sum up (SS_{Sensor}) the individual ISO scores for each axis S_i of one sensor according to Equation 2.

$$SS_{\text{Sensor}} = \sum_i w_i * S_i \quad i = x, y, z \quad (2)$$

4 Results

4.1 The single component model validation

In the single component verification, the load displacement history characteristics of both the center console and airbags were reasonable correlation with the actual tests.

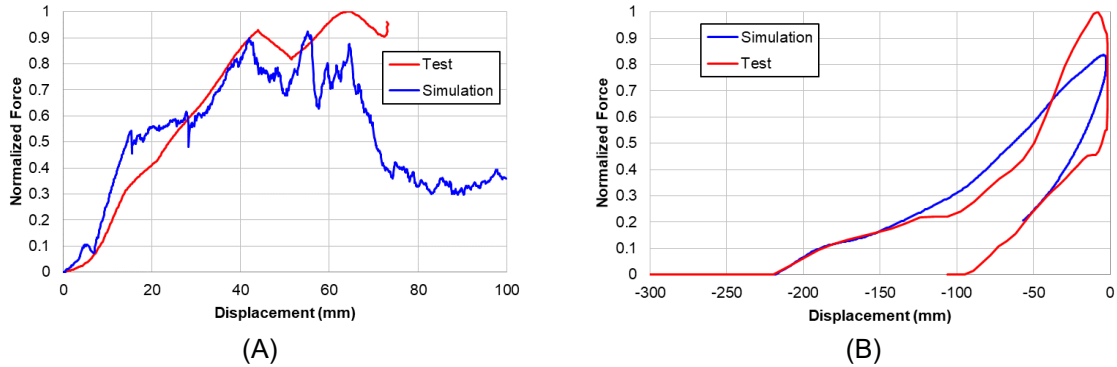

Fig.6: "Comparison of force displacement histories for the center console (A) and airbag impactor (B)".

4.2 The SLED model validation

In the SLED validation of phase 2, the dummy response of the whole body was scored by ISO18571 as shown in Table 1. The results of *SSensor* are with 0.60, 0.58, and 0.73 for the head, spine T4, and Pelvis acceleration, respectively. In terms of the load cell, the upper neck load cell had 0.50 for the force and 0.49 for the moment. In total, the average ISO score for the major accelerometer measurement was 0.64.

The acceleration for the lower body of the World SID dummy showed an ISO score over 0.73, while the upper body was 0.60, indicating lower accuracy for the upper body region than the lower one. Compared to the overall results, the ISO score for the neck load cell was particularly low, indicating that there are issues to be addressed. Comparison of each channels calculated in *SSensor* were shown in Figure 8 and 9.

Table 1: "ISO 18571 score of each channel in SLED test".

Channel	<i>w_i</i>	ISO18571 Score	<i>SSensor</i>
Head accelerometer	0.09	0.32	0.60
	0.35	0.66	
	0.57	0.59	
T4 accelerometer	0.19	0.56	0.58
	0.64	0.61	
	0.18	0.44	
Pelvis accelerometer	0.14	0.51	0.73
	0.63	0.84	
	0.24	0.52	
Lower Neck load cell force	0.09	0.21	0.50
	0.38	0.44	
	0.53	0.59	
Lower Neck load cell moment	0.66	0.53	0.49
	0.19	0.24	
	0.15	0.64	

Figure 7 shows the comparison of the head kinematic at maximum head excursion timing. Simulation kinematic was similar with the experimental one.

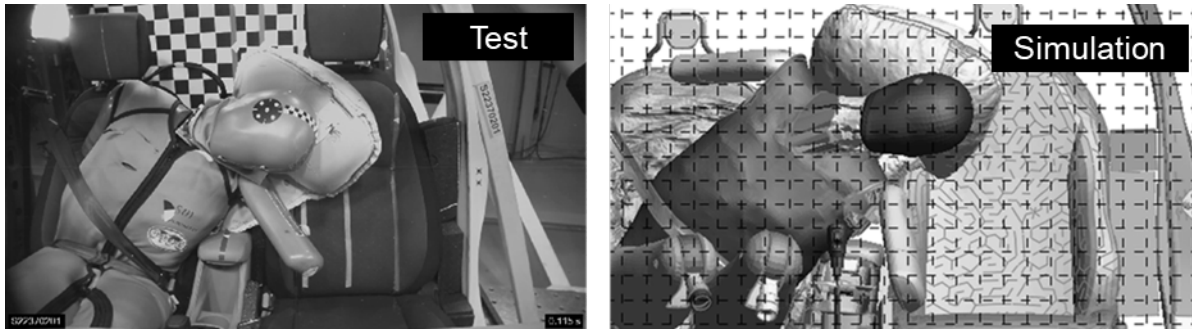

Fig.7: "Comparison of head kinematic video at maximum head excursion".

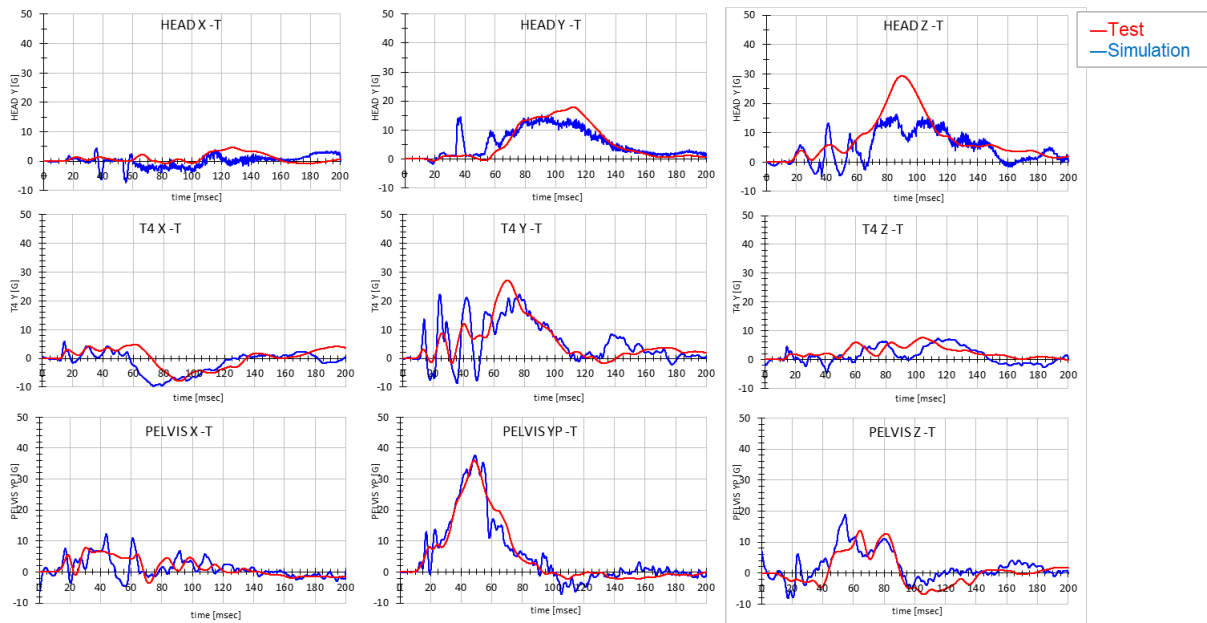

Fig.8: "Comparison of accelerometer time histories of the WorldSID channels".

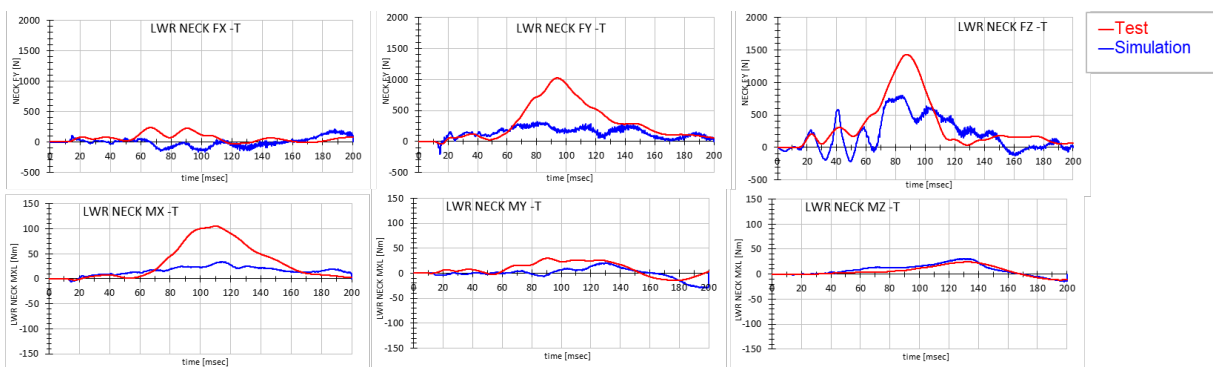

Fig.9: "Comparison of force moment time histories of WorldSID neck load cell".

5 Discussion

By reproducing the SLED test in simulation, the average ISO score of 0.64 indicates a reasonable result for reproducing the actual test as the starting point of the virtual test. However, there are some areas, such as T4 and Neck where the ISO score is low compared to other channels. The T4 acceleration magnitude was large gap around 50msec. It may cause that frequency response differs during the airbag deployment time. The simulation wavelength was similar with the test. But amplitude was large gap between two. In addition, thoracic response of WorldSID was validated using impact test by DYNAmore.[7] It means the airbag deployment force was higher in the simulation. The initial airbag deployment was issue using the particle method used in this study. Further investigation is needed to be improved the model accuracy.

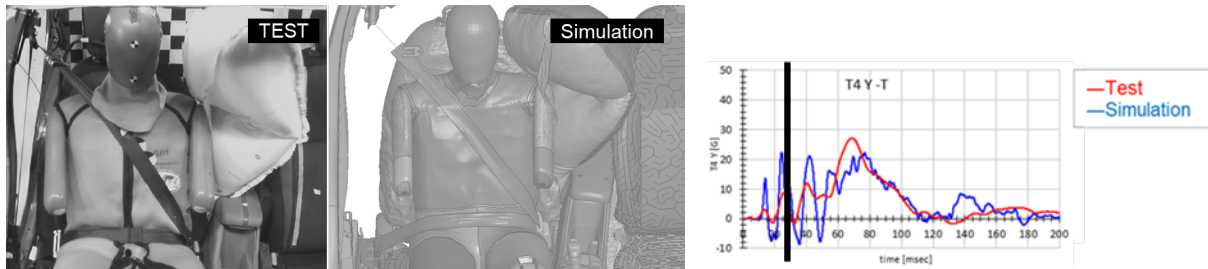

Fig.10: "Comparison of movie during the airbag deployment at 30 msec

For neck of the WorldSID dummy, the ISO score was particularly low. According to the WorldSID user report, in case of the high-gravity pendulum impact, neck force z axis has a gap even even if the configuration is simplified.[7] It may suggest the velocity dependence may be modified to be improved. Further improvement of both models is considered necessary for the future work.

6 Summary

In this study, we compared the far-side simulation and the test with far-side airbag, and calculated ISO score as a benchmark. It obtained 0.64 as the mean of major channels showing reasonable results to reproduce the test. Spine T4 and Neck load cell is further investigated to improve more accuracy in the future.

7 Literature

- [1] Japan Cabinet office : " FY2021 Status of Traffic Accidents and Current State of Traffic Safety Measures", White paper, 2022, 5
- [2] Klug, C et al. : " EURO NCAP VIRTUAL TESTING - CRASHWORTHINESS", 27th Enhanced Safety of Vehicles conference , 2023, 5
- [3] LIVERMORE SOFTWARE TECHNOLOGY CORPORATION (LSTC): " LS-DYNA® KEYWORD USER'S MANUAL LS-DYNA R9.0", [LSDYNA Manuals \(ansys.com\)](https://www.lstc.com/ansys-ls-dyna-manuals) , 2016, 5
- [4] ISO/TC 22/SC 36 Safety and impact testing: " ISO/TS 18571:2014", ISO Road vehicle systems, 2014, 64
- [5] Sugaya, H et al.: " Recent investigations of Side Curtain Airbag Deployment Simulation using CPM", 9th European LS-DYNA conference, 2013, 2
- [6] Euro NCAP.: "EUROPEAN NEW CAR ASSESSMENT PROGRAMME", VIRTUAL FAR SIDE SIMULATION & ASSESSMENT PROTOCOL, 2024, 13
- [7] Stahlschmidt, S et al.: "PDB LS-DYNA WorldSID 50th – Version 7.6.1 User's Manual Manual Release 0.0 ", DYNAmore GmbH , 2022, 88,179