

## Application of Shell Honeycomb Model to IIHS MDB Model

Authors:

Shigeki Kojima  
TOYOTA TECHNICAL DEVELOPMENT CORPORATION

Tsuyoshi Yasuki, Koji Oono  
Toyota Motor Corporation

### ABSTRACT:

This paper describes a new finite element modeling method of Aluminum honeycomb using shell elements. It is our new modeling method that cell size of honeycomb structure is enlarged to increase time step size for FEM analysis, and compressive strength is controlled by thickness of shell elements.

New modeling method was applied to IIHS moving deformable barrier model, and side impact analysis with a full vehicle model was performed. The result of simulation using a new barrier model showed much better correlation with a test result than previous simulations.

### Keywords:

Automotive Crashworthiness, Side Impact, Moving Deformable Barrier (MDB), and Aluminum Honeycomb

# Development of IIHS Side Impact MDB Model using Shell Elements

6th European LS-DYNA Conference  
29<sup>th</sup> ~ 30<sup>th</sup> May 2007

Shigeki Kojima  
TOYOTA TECHNICAL DEVELOPMENT CORPORATION

Tsuyoshi Yasuki, Koji Oono  
Toyota Motor Corporation



1/16

## 1. Motivation of Study #1

- Side impact simulations using MDB model with a **SOLID** Aluminum honeycomb model were performed. (~2005)

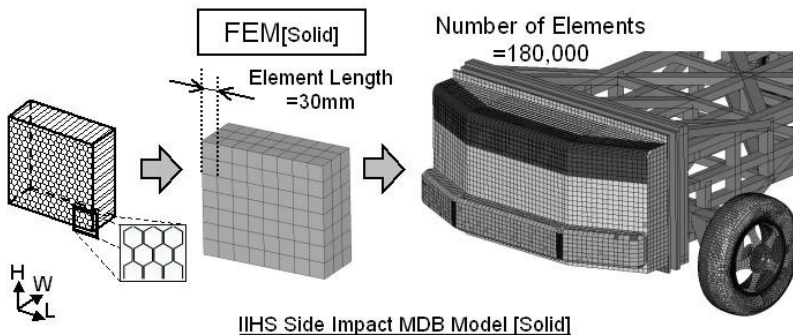

2/16

# 1. Motivation of Study #2

- Modified MAT126 can simulate direction dependency of real honeycomb compressive strength.

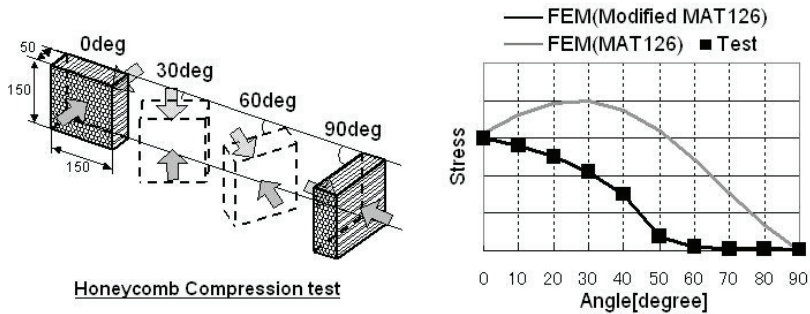

3/16

# 1. Motivation of Study #3

- Deflection and deformed angle of FE B-pillar was smaller than the test.

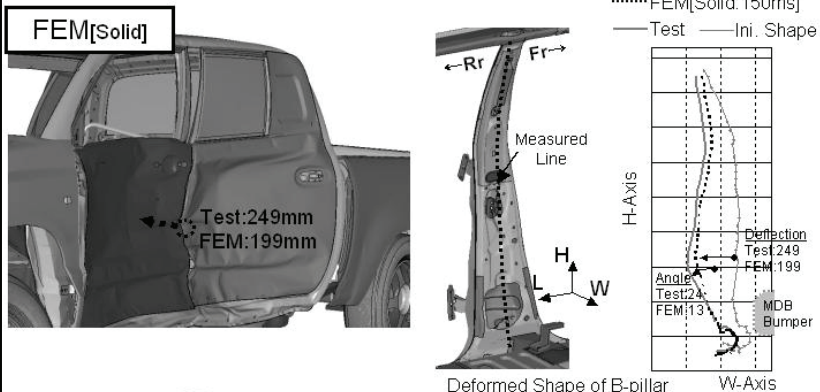

4/16

# 1. Motivation of Study #4

- Deformed angle of FE bumper honeycomb was smaller than the test.

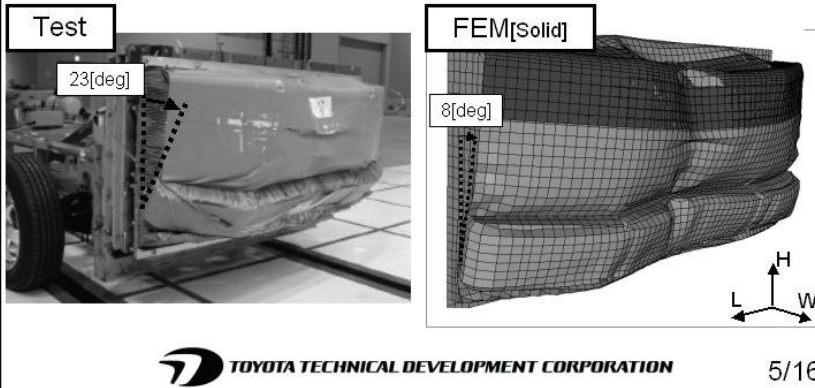

# 1. Motivation of Study #5

- Excessive strength that was caused by hourglass control might prevent the bumper honeycomb rotation.

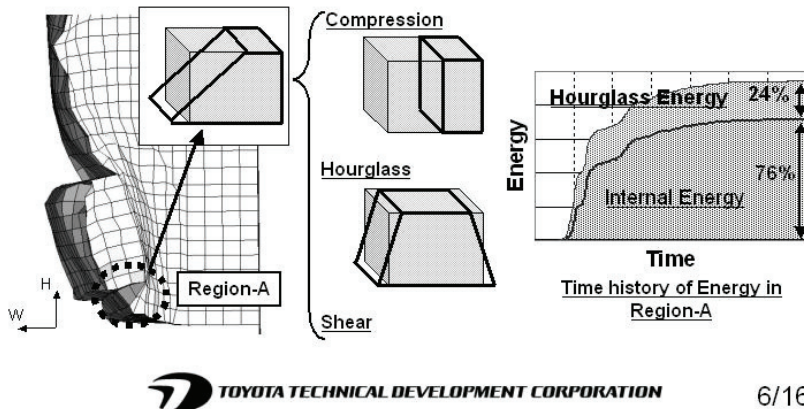

# 1. Motivation of Study #6

- Shell elements was applied to a honeycomb model to reduce excessive strength that was caused by hourglass control for solid elements.

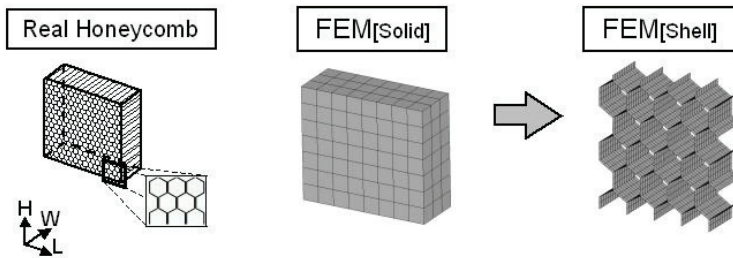

# 2. Shell Honeycomb Model #1

- Cell size of honeycomb model is enlarged to reduce the number of elements.
- Fr side edge of honeycomb shell elements are pre-crashed.

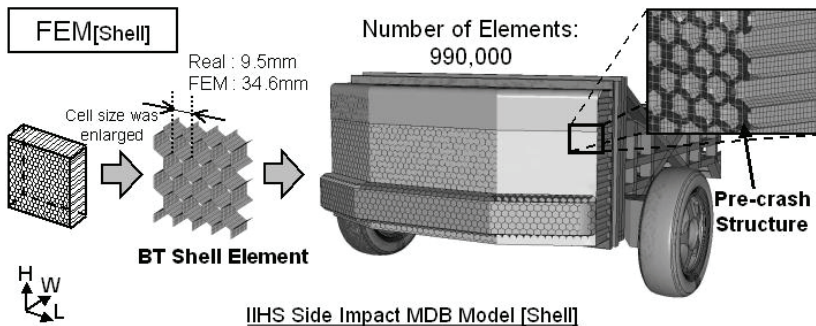

## 2. Shell Honeycomb Model #2

- Black shell thickness is double size of gray element.
- Compressive strength is controlled by shell thickness.

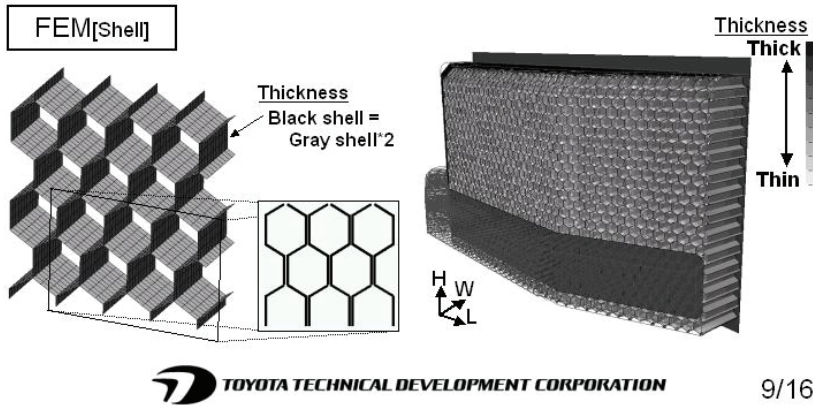

## 3. Result (Rigid Barrier Test) #1

- Two rigid barrier test and FE analyses were performed.
- Both FE results are similar to the test.

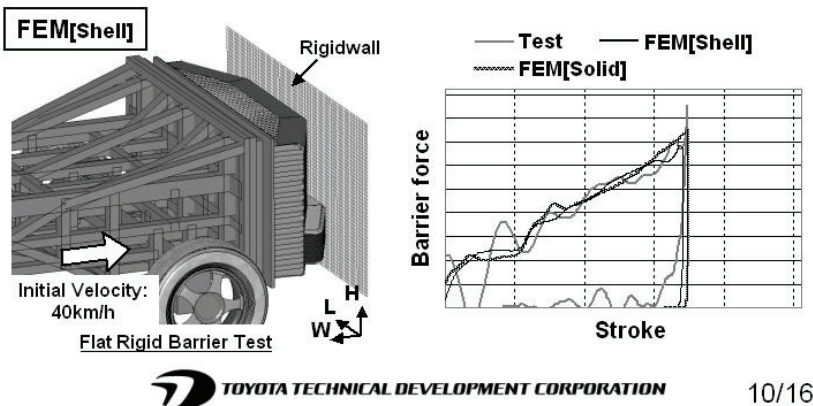

### 3. Result (Rigid Barrier Test) #2

- Both FE results are similar to the test.
- Shell honeycomb model can simulate compressive strength of IHS side impact barrier.

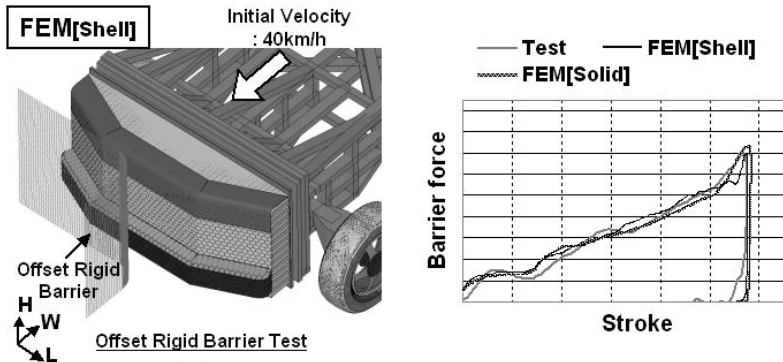

**TOYOTA TECHNICAL DEVELOPMENT CORPORATION**

11/16

### 4. Result (Full Vehicle Side Impact) #1

- Full vehicle side impact collision analysis was performed.
- A simulation with shell MDB model requires 135% CPU time of solid MDB.

Hardware, CPU time

MDB Model	Shell-MDB	Solid-MDB
Hardware	Fujitsu PC-Cluster 32CPU	
CPU time ratio	1.35	1.0

Vehicle Model  
Number of Elements: 1,570,000

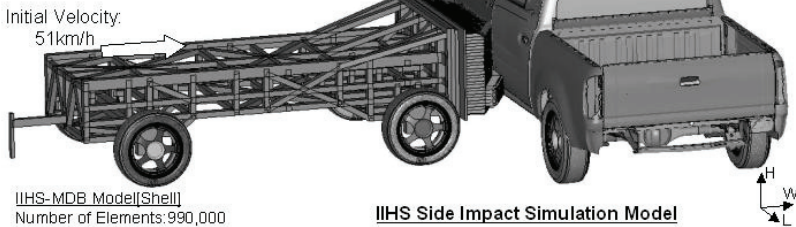

**TOYOTA TECHNICAL DEVELOPMENT CORPORATION**

12/16

## 4. Result (Full Vehicle Side Impact) #2

- Shell honeycomb model shows coincident deformed shape with the test.

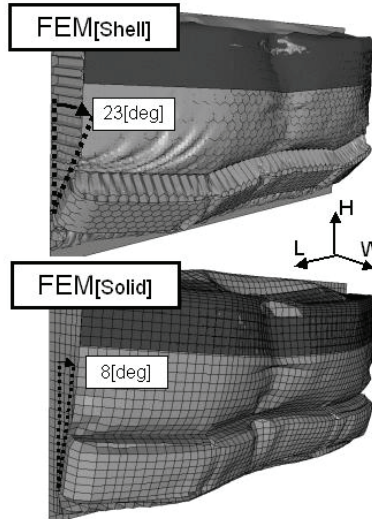
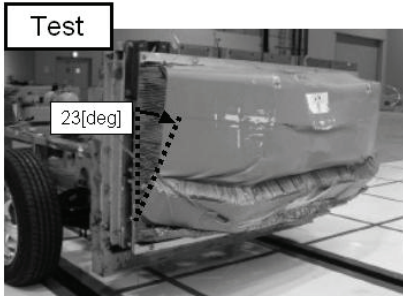

## 4. Result (Full Vehicle Side Impact) #3

- Shell MDB model reduces the ratio hourglass energy to total energy.
- Excessive strength that prevented bumper honeycomb rotation has been reduced.

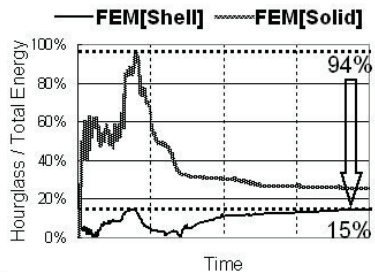
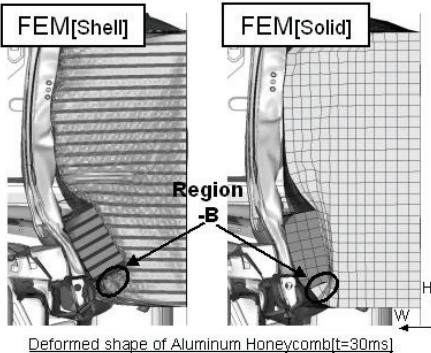

Time history of energy ratio[HG/Total] in Region-B



## 4. Result (Full Vehicle Side Impact) #4

- Shell MDB model shows coincident curved shape of B-pillar with the test.

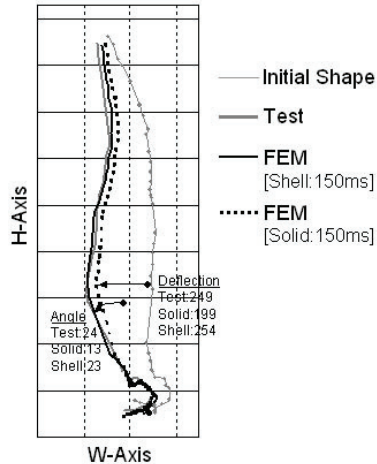
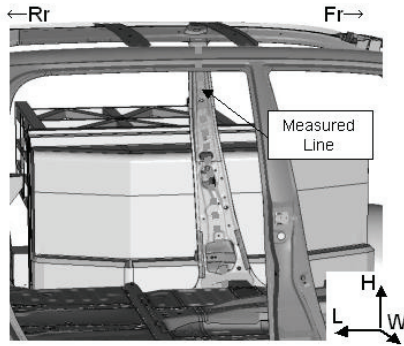

15/16

## 5. Conclusion

- An Aluminum honeycomb model was applied to IIHS side impact MDB model.
- Shell honeycomb model can simulate compressive strength of IIHS side impact MDB.
- Shell barrier model shows better correlation of vehicle B-pillar deformation than solid barrier model in a side impact collision analysis.



16/16

## **REFERENCES**

1. Insurance Institute for Highway Safety: Side Impact Test Protocol, <http://www.iihs.org/ratings/protocols/default.html>
2. Dr. Tore Tryland, "Alternative Models of the Offset and Side Impact Deformable Barriers", 9th International LS-DYNA Users Conference, p.1-9 - 1-16
3. Shigeki Kojima, Tsuyoshi Yasuki, "Development of Aluminum Honeycomb Model Using Shell Elements", 9th International LS-DYNA Users Conference, p.18-1 – 18-10
4. Robert Mayer, Scott Webb, J.T. Wang, Bill Liu, "Sled tests and simulations of offset deformable barrier", International Journal of Vehicle Safety Volume 1, p.238 – 251
5. Andreas Hirth, Paul Du Bois, Dr. Klaus Weimar, "A Material Model for Transversely Anisotropic Crushable Foams in LS-DYNA", 7th International LS-DYNA Users Conference, p.16-23 - 16-34
6. Tsuyoshi Yasuki, Noriko Watanabe, "Vehicle Crash Analysis Applications to a Vehicle Development", TOYOTA Technical Review Vol.51 No.1 Jun.2001, p.54 – 59
7. Koji Nojima, "Modeling and Accuracy of Offset Crash Deformable Barrier - Real phenomena and modeling technique", JSAE 2001, p.37 - 41