

**OPTIMISATION AND ROBUSTNESS OF SIDE AIRBAG
DESIGN AND ANALYSIS**

Tayeb Zeguer
Jaguar cars

Abstract

In order to yield significant added value, computer model need to reach to a level of reliability that enables decisions, which are only based on simulation results. Airbag deployment is highly non linear and non reproducible. Scatter in all system properties and boundary conditions also cause scatter in the performance of the system. The aim of this paper is to use stochastic simulation approach to include this natural scatter into the computer models. This allows evaluation of the performance scatter and thus an assessment of reliability and quality of the simulated system. Stochastic simulation can be used for system improvement, which offers a further application tool for system optimisation. The problem is not to find optimum solution in a mathematical sense, but to develop sufficiently good and especially robust solutions for real world situations.

In this paper stochastic approach will be introduced and applied to the side airbag deployment.

Introduction

Variation in variable quantity is inherent to all physical systems hence a tool capable of analysis, comparing and validating stochastic models is needed. In deterministic analysis, intrinsic dispersion is missing altogether from the model which immediately puts the analysis in a situation where trying to validate, understand and gain confidence in the model becomes difficult. Engineers are often compelled to choose between ignoring the scatter or adding safety factors.

If scatter is ignored, then it is must be assumed that degree of scatter within the model is sufficiently low so that deterministic analysis delivers acceptable results.

The use of stochastic analysis is to reflect one of nature's most important features, uncertainty.

A typical engineering task during the development of any system, e.g. a car, is to improve its performance. This is done in order to meet design targets that are set either internally or externally. Improvement can be achieved by simply using experience based design rules or by using methods that systematically drive the system towards a better solution; such as using optimisation tools. Very often attempts to find an optimal solution for a system are made. The optimal means that no better solution exists. Considering the complexity of the system and the vast number of variables that are to be optimised. It is possible that no solution may be found.

Robustness:

A well performing system is of little value if it performs so only under perfect conditions. If slight deviations from these conditions which can never be avoided in the real world dramatically deteriorate the performance, a system is called non robust. Robustness means finding an acceptable balance between the scatter of the inputs (system parameters) and the scatter of the performance reference MARCZYK [1999]. The performance of the system will vary, but its scatter should be in the same range as the scatter of its inputs. If the system, for example is subject to typical material and production tolerances in the range of 5-15% of the nominal value, and its performance scatter is larger than 50% then this is considered a non-robust design.

A simple way to assess the robustness of a system is to compare the coefficients of variation (CV) for both inputs and outputs obtained from a stochastic simulation. The coefficient of variation is basically the percentage of scatter measured as the standard deviation of a variable.

$$CV = \frac{s}{\bar{x}} = \frac{SSD}{SM}$$

Where SSD = Sample Standard deviation
And SM = Sample mean

It therefore is independent from the magnitude of the variable and can be used to compare variables of different magnitude.

Stochastic improvement:

The stochastic improvement method is a natural and simple method. A model is described by a set of input variables x_i , and a set of output (performance) variables y_i . Most of the inputs are subject to random noise, i.e. scatter due to tolerances and imperfections. Some inputs are design variables; i.e. variables that can be modified within certain limits in order to improve the performance.

The improvement procedure is as follows:

1. Create LS_DYNA model using nominal data.
2. Define a target performance of the system; i.e. define all or some output, which is the desired value. Every input and output parameters from in LS_DYNA file can be chosen as a variable and target output respectively.

3. Define the scatter (distribution) of the noise variables and define the scatter and allowable range of the design variables. The variables are chosen from LS_DYNA input file.
4. Generate a random Monte Carlo sample of LS_DYNA models and run them through the solver.
5. For each LS_DYNA model in the sample calculations of the Euclidean distance from its result to the target performance.
6. Find the minimum distance, i.e. identify the model, which is closest to the target. If the distance is small enough, stop the process.
7. Modify the distributions of the design variables, so that the mean value is shifted to the value that was used in the closest model.
8. Go to step 4

This method is known as return mapping reference DOLTSINIS. [1998]. This idea of the method is to shift the results cloud toward the desired point. Due to the fact that for each step a cloud is generated it is possible to observe changes in the shape of the cloud. Sometimes the cloud becomes wider as it approaches the target. This indicates that the scatter increases. An initially robust design turn out to become non robust once it comes close to the target. Such important information is automatically generated during a stochastic improvement process.

As stated above no assumptions have to be made in order to use this method. Also the number of variables is nearly unlimited and does not influence the number of solver calls that is required reference MARCZYK [1999]. So one can define all variables that are stochastic in reality (noise) as stochastic in the model. The number of actual design variables is usually relatively small for practical reasons, as not many things can be changed arbitrarily in a complex system such as a car.

Difference between Monte Carlo Simulation and DOE/RSM type methods:

DOE is a technique, which has been originally conceived to reduce the number of physical tests when the effects of a certain number of parameters were to be evaluated. Imagine, for example, that we can crash only three cars and we want to evaluate the influence of six parameters on the performance. DOE can help design i.e. plan the experiments in way that the effect of each parameter is exposed. Today, DOE is used to sample the design space of a problem and provide points on which a response surface (RS) is built. Normally, due to cost reasons, the order of this surface is limited to two. However, this fact may be seen as an arbitrary a priori choice not based on physics of the response, but on cost consideration alone. Clearly, a response surface is a differentiable and continuous quantity. In reality, however, if scatter is introduced into a computer model (the scatter that is due to physics) the response point will arrange into clouds (we call them response clouds) over which it will be practically impossible to impose any surface. Response clouds contain, of course, the results of Monte Carlo simulation and provide fantastic insight into the nature of the problem, in addition to valuable information on its physics. Since response surfaces are approximate slices of the more realistic response clouds, they constitute, together with DOE, destructive techniques. Monte Carlo, on the other hand, is a non-destructive technique and preserves all the information that a model is able to deliver.

Main advantages and characteristics of Monte Carlo Simulation (MCS):

There are a number of advantages:

- Monte Carlo simulation is completely generic. You can run an MCS with any type of application.
- Monte Carlo simulation solves a family of problems, not just a single nominal case.
- Monte Carlo simulation in the true sense, contains all other applications, like optimisation, parametric studies, sensitivity analysis, what if analysis, etc. in fact, it is the most complete procedure from the point of view of the information it delivers.
- Monte Carlo simulation provides a natural link to experimentation.
- Monte Carlo simulation enables to treat multi disciplinary problems just as easily as simple problems.
- Monte Carlo simulation is non destructive in that it preserves all the information that a numerical model is able to deliver. This is not the case with the response surface method.
- Monte Carlo simulation is not just an algorithm; it is a technology that will boost innovation in CAE on a major scale,

Application of stochastic analysis to airbag deployment:

The analysis was divided into three runs:

Run 1: Finding the most important parameters

- Define design target performance
- Define input parameters range including their stochastic variation to modify.
- Find the most important parameters and relationship between inputs and outputs.

Run 2: Model improvement

- Simplify the input and output parameters as found in Run 1
- Optimise the design to obtain the nominal values

Run3: Robustness analysis

- Use the nominal values from the optimised Run 2
- Carry out robustness analysis

Run 1: Finding the most important parameters

Define target performance:

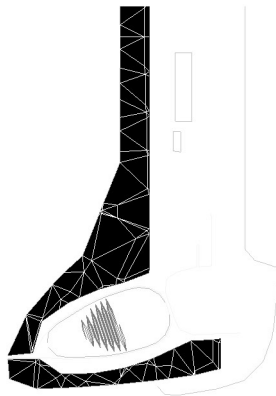

Figure 1 airbag mounted seat assembly

Coverage area:

To define a mounting location for the side airbag within the seat figure 1, practice within the airbag industry guided the definition of two dimensional protection zones for the airbag, relative to occupant thorax and vehicle interior. While this process is straightforward, it is critical to ensure that the airbag does not encroach substantially into the abdominal region. As discussed by Cavanaugh [1990], the abdomen is far more compliant and less tolerant of loading, when compared with the thorax.

The two-dimensional airbag profile represents the pressurised condition, hence plan area contraction must be compensated for, when defining the flat airbag pattern. The four market targets in Figure 2 and Figure 3 are the lower and upper boundaries defining the area of coverage. The four nodes in the airbag define this target. When combined with inflator dimensions, the folded airbag pattern will give a baseline package volume to evaluate seat mounting.

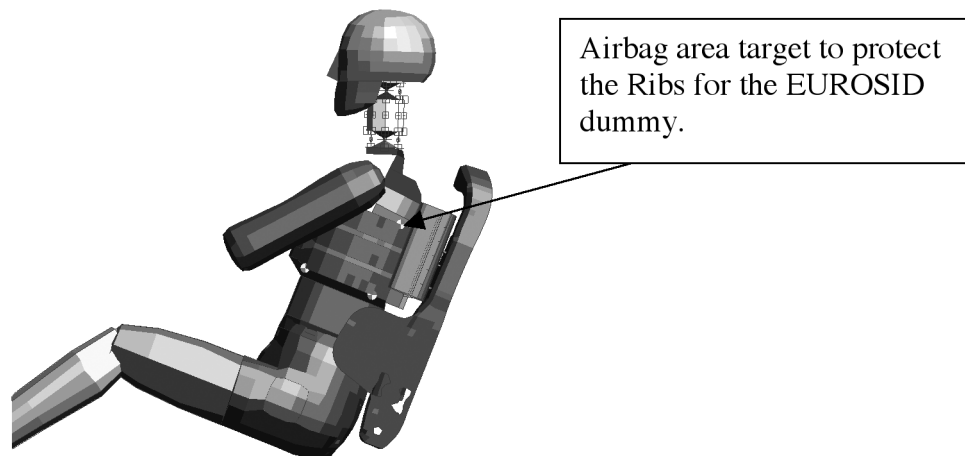

Figure 2: Airbag area coverage target to protect the ribs.

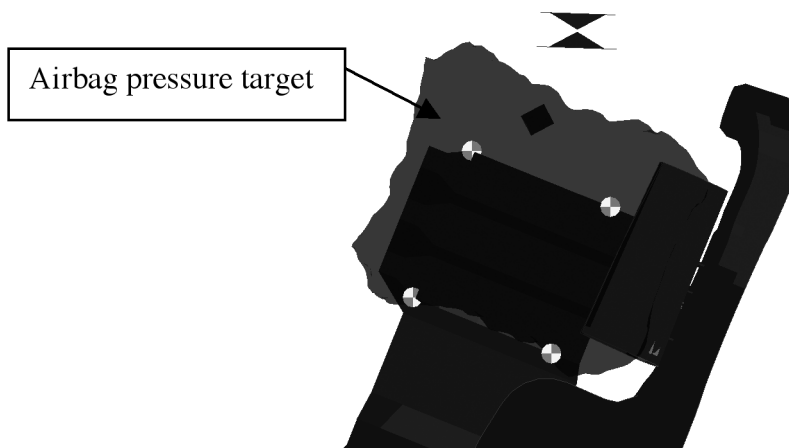

Figure 3 Area coverage and pressure target during airbag deployment.

Airbag pressure target:

Side airbags are used to enhance the safety of the vehicle by protecting the occupant from severe injuries. The pressure target can be selected by the limit set by side impact legislation. However, this philosophy may neglect to consider the wider scope of occupant safety. While side impact legislation is based upon injury prevention, test methods and limits are derived from vehicle usage statistics, which may be market specific. The target should be defined by human biomechanical injury tolerance. In essence, it should be clear that vehicle occupants, as human beings, have much the same tolerance to injury in any market; only the physical population spread is likely to differ.

Due to the compact design of the airbag module, pressure-tapping readings showed a local manifold pressure, which did not represent the airbag internal pressure until a more stable environment existed in the system at about 10 ms from trigger. The pressure can also be achieved by using analysis optimisation tools.

Define parameter to modify:

Components	Units	Initial value	Design Interval	
			L-L	to L-R
Seam strength in X direction	N	100.0	80	200
Seam strength in Y direction	N	100.0	80	200
Seam strength in Z direction	N	100.0	80	200
Seam displacement failure criteria	mm	0.500	0.3	1.0
Inflator Characteristics factor	Scale	1.000	0.4	1.2
Airbag porosity factor	Scale	1.000	0.8	1.2
Airbag jetting Z direction	mm	933.7	840	1027
Airbag jetting cone angle	Radian	0.530	0.1	0.8
Scale factor for jet efficiency	Scale	1.000	0	3
Foam material load curve	Scale	0.500	0.4	1.20
Seat tether thickness	mm	0.500	0.3	2.0
Airbag fabric thickness	mm	0.300	0.25	0.35
Airbag plastic cover thickness	mm	1.500	1.0	2.00
Airbag guide thickness	mm	1.000	0.30	1.50

Figure 4 Design parameters set up

Define targets:

Paramater	Units	Target value
Bag pressure at 10 ms	N/mm ²	0.200
Bag pressure at 12 ms	N/mm ²	0.190
Bag pressure at 14 ms	N/mm ²	0.180
Bag pressure at 16 ms	N/mm ²	0.170
Bag pressure at 18 ms	N/mm ²	0.160
Nag pressure at 20 ms	N/mm ²	0.150
Node 3000420	mm	<-69.90
Node 3001033	mm	>88.66
Node 3001036	mm	<-12.10
Node 3001889	mm	>28.30

Figure 5 Target setting

Relationship between various inputs and outputs:

Run1 was set up in ST-ORM with the above input and output variables as shown in Figure 4 and Figure 5. One Run with 50 shots was selected for this analysis. The initial run RUN1 is carried out for sensitivity analysis in order to determine the relationship between various input and output variables and their influence on each other's. This approach is only used to eliminate redundant parameters to speed up the model improvement for large models. The information generated should reduce the complexity of any subsequent improvement runs

After the completion of Run1:

1) Check the correlation of the input variables to see if the number can be reduced. Using the stats module by selecting all input variables and using Anti-Hill plot. A form appears in which the correlation threshold is selected and plots type Figure 6. By selecting IN-IN Figure 7 correlations to look for correlation between the input variables. Setting the correlation to low threshold it becomes obvious that there are no results with a threshold of > 0.5 Figure 8; this means there is no correlation between any of the input variables and hence we can't reduce the number of inputs on this basis at least.

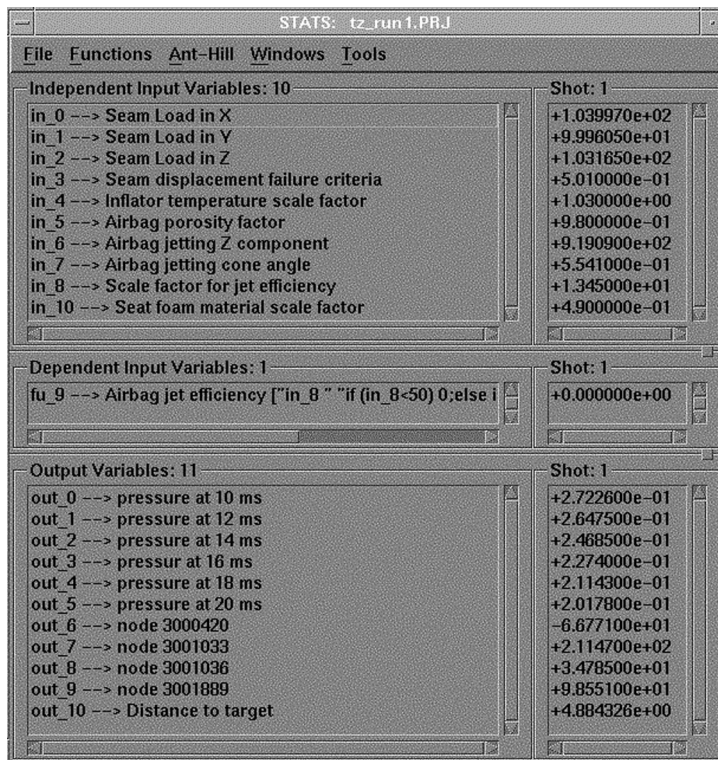

Figure 6 Stats for input and output variables

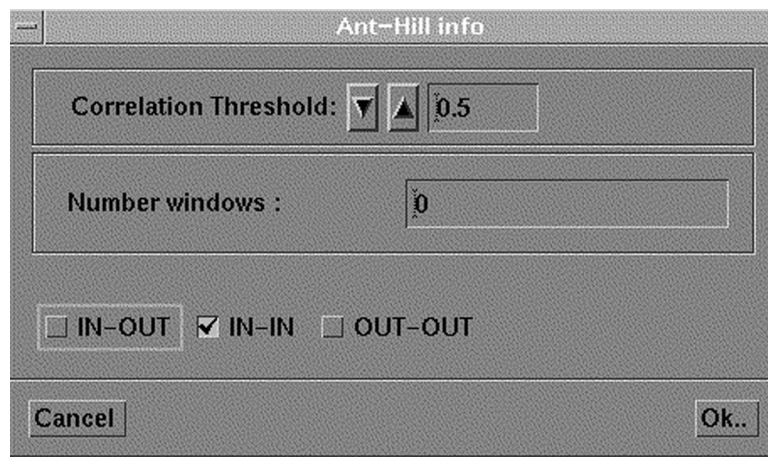

Figure 7 Correlation thresholds 0.5 for Input against Input

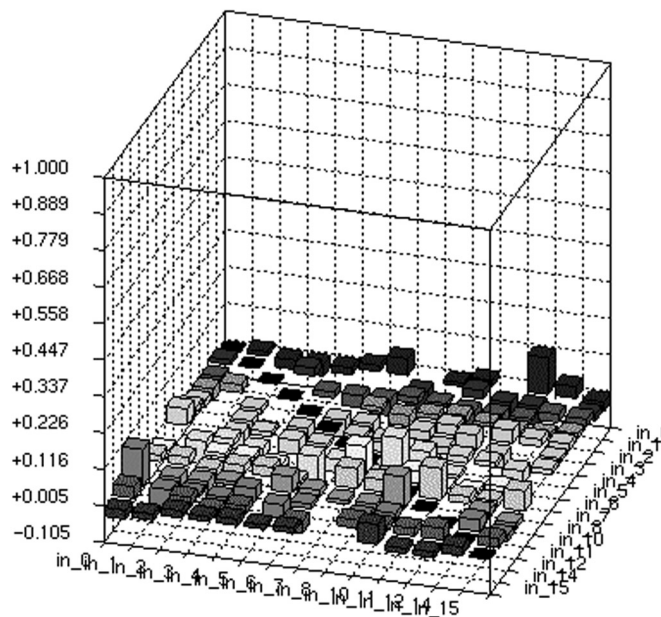

Figure 8 Threshold correlation >0.5 for Input versus Input

Using Anti-Hill plot Figure 9, a strong correlation exists between the pressure at 20 ms and the pressure at 18 ms. Similarly there is a strong correlation between nodal output 3001036 and node 3001033 Figure 10.

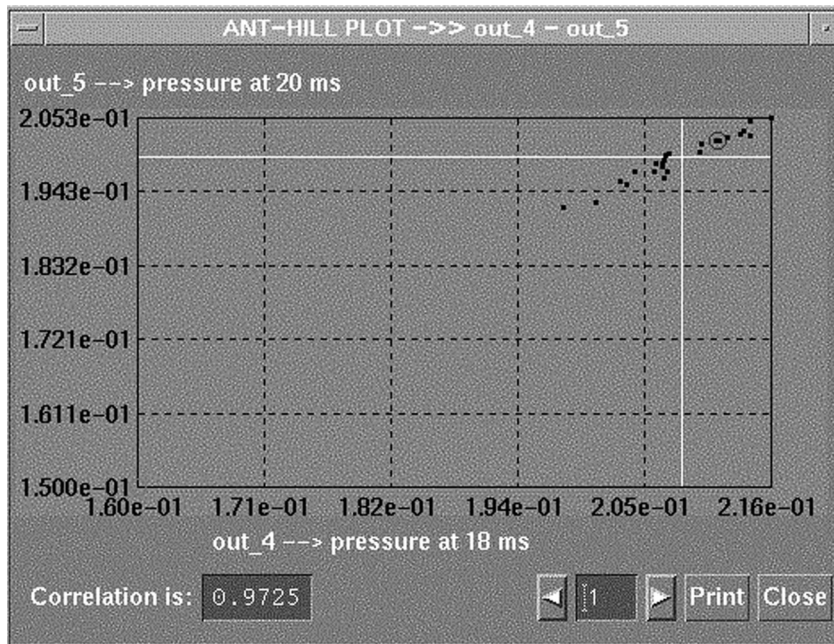

Figure 9 Pressure at 20ms with pressure at 18ms strong correlation 0.9725

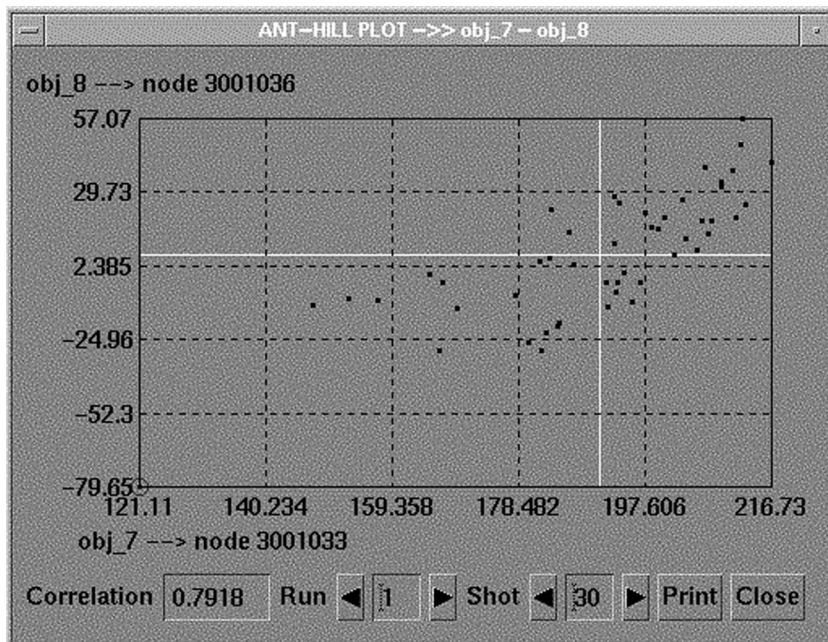

Figure 10 Node 3001036 to Node 3001033 output correlation 0.7503

2) By repeating the above exercise for the output variables. Select the variables, select Ant-Hill plot and OUT-OUT correlation. By adjusting the correlation threshold and noting the number of plots to be created.

In this case here are a large number of correlations of interest, a threshold of 0.5 Figure 11 and Figure 12.

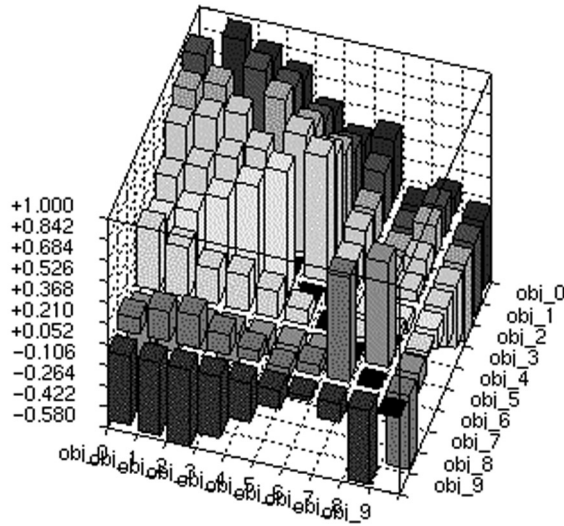

Figure 11 Output against output correlation

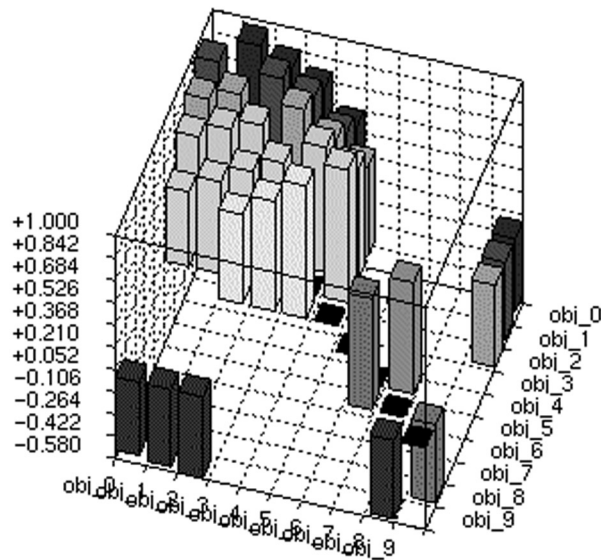

Figure 12 Outputs against outputs correlation greater than 0.5

In an attempt to reduce the amount of plots, the output variables concerned with airbag pressure were selected and repeated the above.

Most of these variables have a correlation with each other so it is recommended to use just the 10ms and 20 ms output variables for any further work. In other words we set targets for the 10ms and 20 ms output points and leave the others inactive.

The OUT-OUT correlation exercise with the four nodal positions were repeated. In this case there is a strong correlation between nodes 3001033 and 3001036 Figure 13. However on inspection of the Ant-Hill plot the correlation is strongly influenced by an outlying point so It was decided not exclude either of these nodes from further work

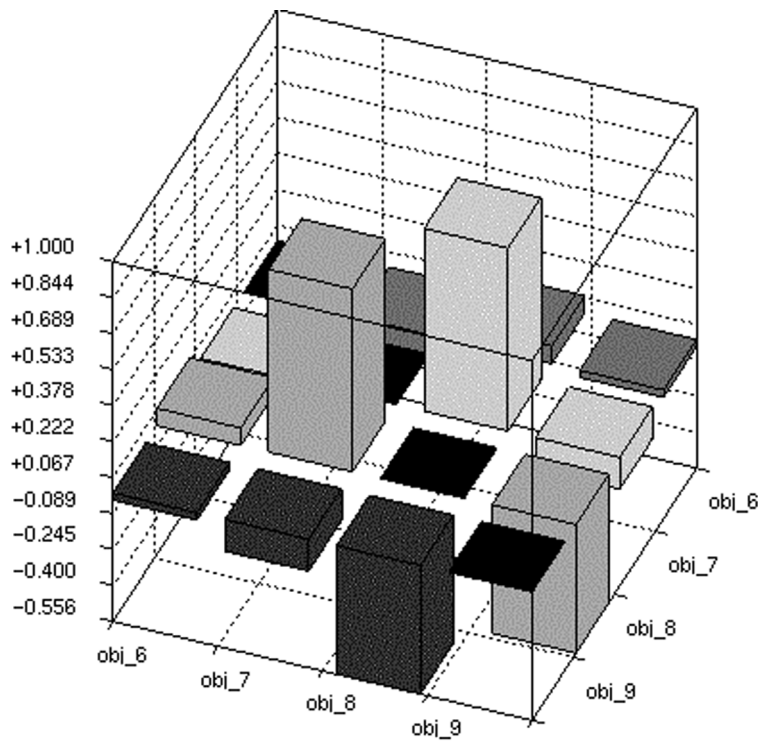

Figure 13 good correlation between objective 7 and 8

3) All input against all output with correlation above 0.5 are shown in Figure 14

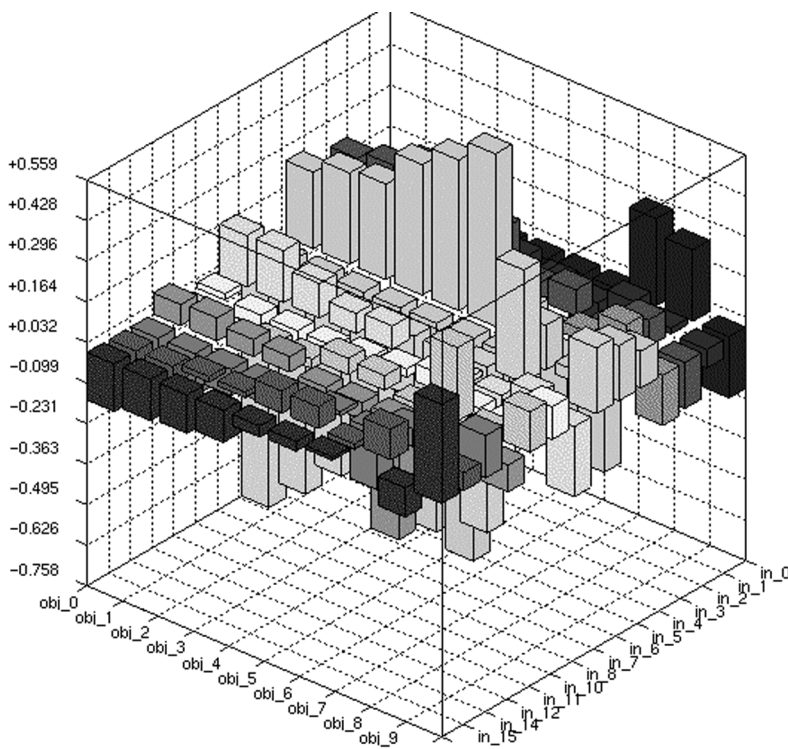

Figure 14 All input versus output

4) The IN-OUT correlation was then inspected to see which input variables are having an effect on the outputs. If the influence is limited we can make them inactive in any subsequent improvement runs. Note that they will still be supplying their stochastic (noise) to the system, just that the distributions won't be shifting in an effort to achieve the various targets we set. So, all the input were selected and just one output variable, say 10 ms pressure output. Ant-Hill plot was selected again and by altering the correlation threshold to about 0.5, this showed which input variable (if any) has influence on the 10 ms pressure value. By continuing this process for the 20 ms pressure value and the 4 nodal positions, the following were found, input variable 4 (Inflator characteristic defined as temperature scale factor), input variable 5 (Airbag porosity factor) and input variable 6 (Airbag jetting Z component) are the only parameters which have a great influence over the all outputs Figure 15.

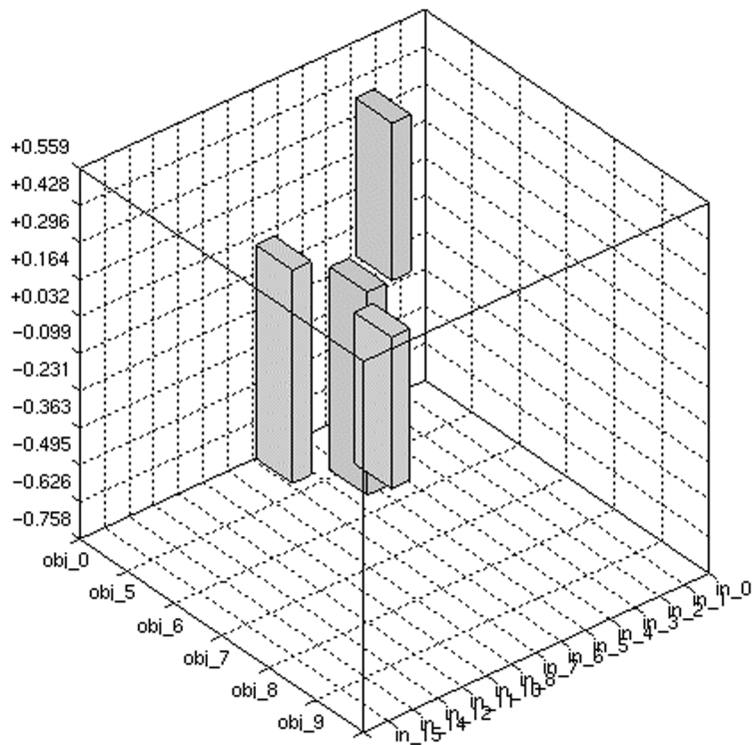

Figure 15 Correlation between important parameters

This does not mean that the other parameters had no influence; ST-ORM may not select an important parameter if its initial nominal value was an already optimised value and its stochastic variation is small. So we will make these input variables active for the improvement phase.

Note that the all the other variables will still supplying their stochastic (noise) to the system, just that the distributions won't be shifting in an effort to achieve the various targets se set. We make the following variables inactive: 1/2/3/7/8/10/12/14. Figure 16.

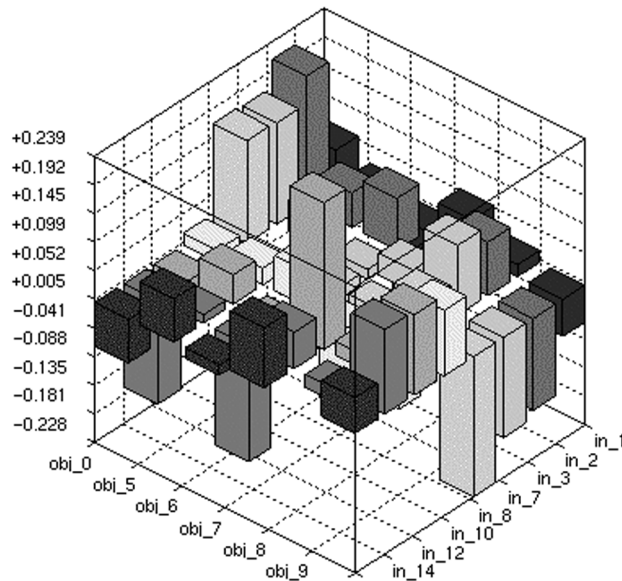

Figure 16 Low correlation between variables

Note that 9 and 13 are dependent on 8 and 12 and therefore are also inactive, this leaves 0,11,15 Figure 17

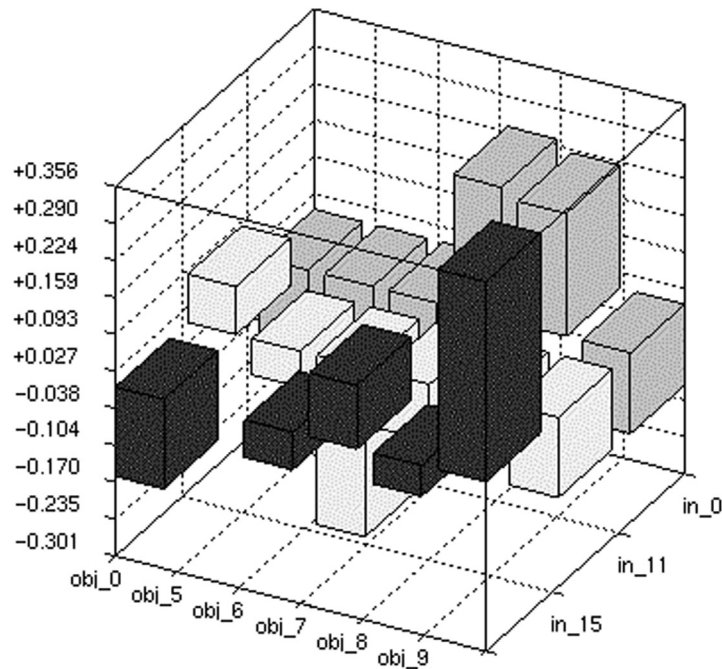

Figure 17 Low correlation between 0,11 and 15

Looking at the nodal position output variables it becomes apparent that none of the input variables have much influence over these parameters. This will make things difficult in a model improvement analysis that may lead to not achieving the target set. Variable 0 and 11 have minor influences so it was recommended to leave them active.

5) In summary:

- Only 10 ms and 20 ms pressures output variables, which will be used for further analysis.
- Only input variables 0/4/5/6/11 and 15 will be used, all others have minimal effect.
- Nodal position output targets will be difficult to achieve due to low correlations.

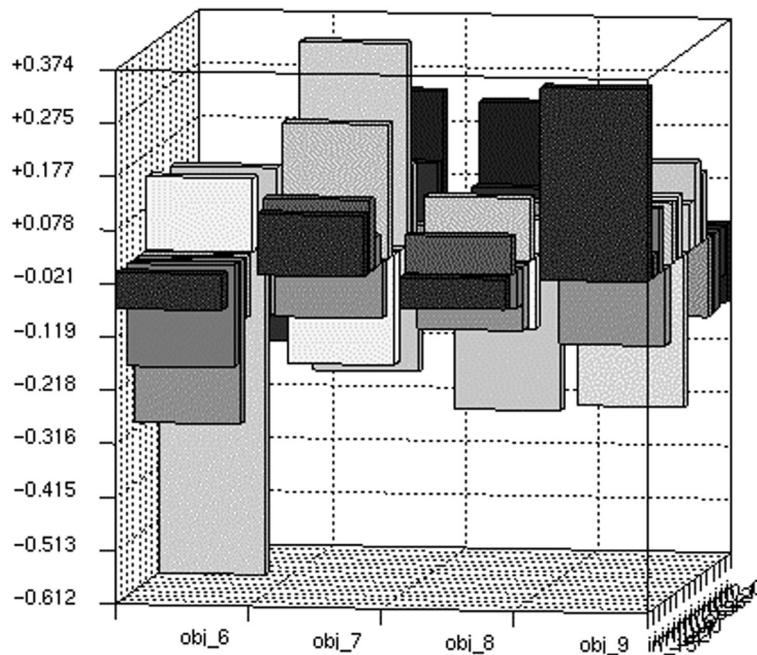

Figure 18

RUN2: Model improvement - 5 runs with 25 shots each:

1) Set variables 1/2/3/7/8/10/12/14 inactive

In ST-ORM select define, run data with 25 shots 5 runs.

Set targets on all 6 of the output variables in side-airbag model. Allowed 6 out of the 16 stochastic input variables to move or vary whilst the other 10 input variables maintained their stochastic distribution with their mean values fixed.

Table 3 summarises the model improvement achieved after 5 analysis cycles. It can be seen that the model is 'improving' - in that the output variables are moving towards their targets, in all cases. I would comment that the improvement is somewhat Figure 19, Figure 20 and Figure 21 show changes in the mean value of typical output variables.

It is interesting to note that there has been significant change in the nodal position output variables (towards the targets) and relatively little towards the pressure targets. This is rather counter-intuitive since previous study of the input v. output correlations led us to believe that the correlation for these pressure variables was stronger. However, it may be partly explained by the fact that we set all the 'weightings' for the output variables as equal. This means that ST-ORM will work hard to move the model towards all targets equally. If it is judged that the pressure targets are of more importance then a higher weighting in the improvement set-up should be used. Since the correlations are stronger it is expected to see a more dramatic improvement in this case.

In all cases the mean of the output variables is still changing, indicating that there is some additional improvement to be achieved. However, at this stage the rate of change of these output variables is small. This may be explained as follows. In some cases the 'width' or 'Coefficient of Variation' of the design input variables is very narrow or small compared to the actual design envelope. Looking at the statistical means and conclusion can be made on the robustness of the analysis.

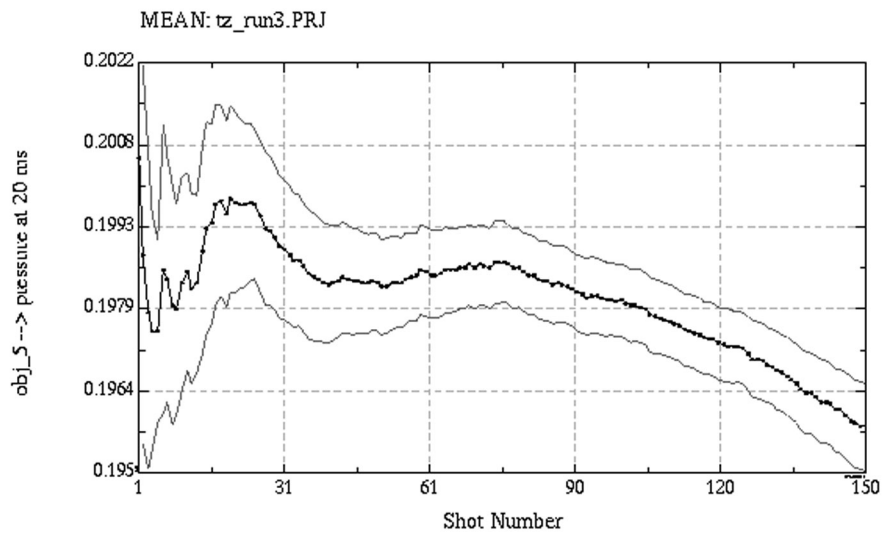

Figure 18

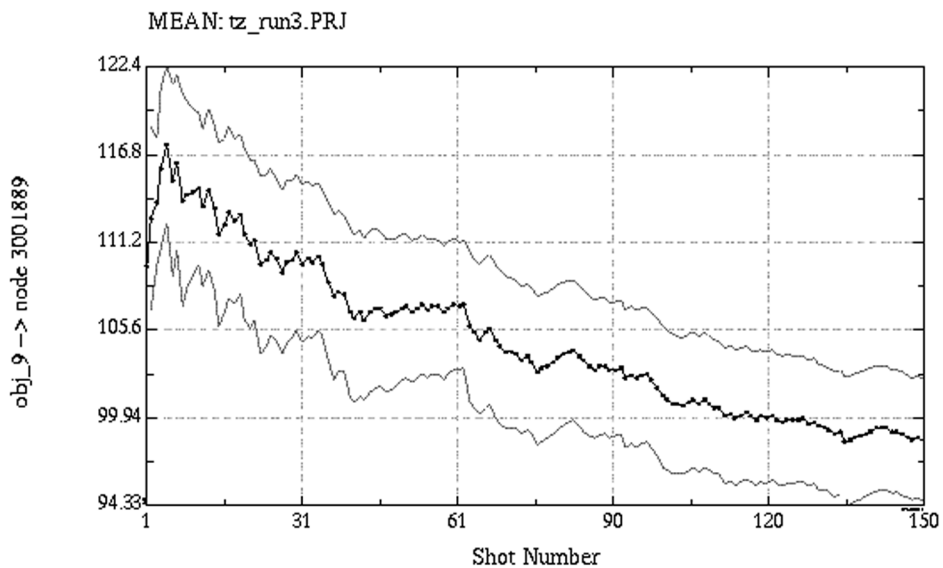

Figure 19

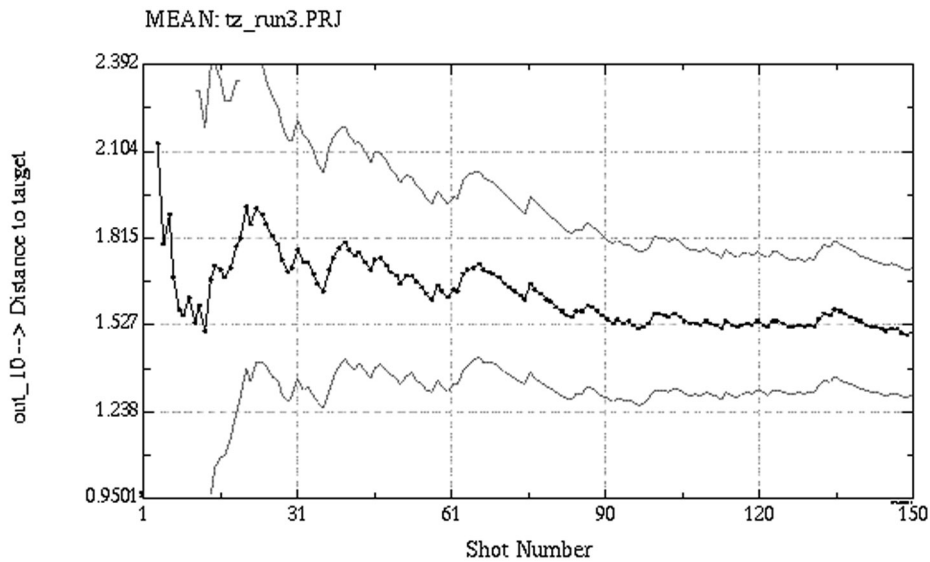

Figure 20

Robustness analysis

After completion of improvement runs the nominal values will be obtained. A robustness analysis is carried out. Figure 21 summarise the coefficient of variation if the input and outputs.

By examining the variations in input CV% from 2.5% to 11.7%. The output varies from 1.8% to 6.9%. It can be concluded that the solution is robust. Other statistical information need to be considered to make sure that the analysis is robust.

Moments/Statistics Report Information				
N.Var	Num. shots	Mean	CV(%)	Description
dv_0	25	97.5	10.6	Seam Load in X
dv_4	25	0.515	11.7	Inflator temperature scale factor
in_10	25	0.499	2.5	Seat foam material scale factor
dv_16	25	0.975	4.0	porosity scale factor
obj_0	25	0.233	6.9	pressure at 10 ms
obj_5	25	0.179	1.8	pressure at 20 ms

Figure 21 Statistics report information

Conclusions

Good correlations to tests is routinely obtained using LS_DYNA software in all field of engineering applications. Quality programmes have focused on detecting and correcting design defects. Stochastic simulation encompass something broader, it provides specific method to re create the process so that defect and errors never arise in the first place.

High standard of CAE will only be achieved by integrating the stochastic simulation in product development. The ability of improving the robustness of a product by controlling the scatter of its manufacturing and design parameters with a great potential for cost reduction without losing performance.

It has been shown in this paper that stochastic approach can improve design and obtain a robust solution in selecting the nominal values used in the analysis and design.

Stochastic simulation offers a further application, the improvement of the system. This method will achieve a sufficient good robust solution for real world situation such as deployment of side airbag through the seat foam and could be extended to all crash scenarios.

References:

- CAVANAUGH cavanaugh, J.M, Huang, Y., Zhu, Y., king, A.I “ regional tolerances of the shoulder, thorax, abdomen and pelvis to padding in side impact” SAE no 930435
- DOLTSINIS [1998] Doltsinis, I. (1998). Method of statistical comparison, ICA reports No. 55, Stuttgart.
- HURTADO [1998] Hurtado, J.E., Barbat, A. H. (1998), " Monte Carlo techniques in computational stochastic mechanics, Archives of computational methods in engineering, 5, 3-30.
- JAMES [1997] James, R. S. (1997), " Matrix analysis for statistics" , John Wiley & Sons, Inc., New York.
- MARCCZYK [1999a] Marczyk, J.: "Principles of simulation based computer aided engineering" FIM publications, Barcelona, 1999.
- MARCZYK [1997] Marczyk,J. (1997)," Meta computing and computational stochastic mechanics, in Computational stochastic mechanics in a meta computing perspective."
- MARCZYK [1999b] Marczyk, Jacek " Recent trends in FEM" NAFEMS world congress. Rhodes Island, April 1999.
- MARCZYK [2000a] Marczyk, Jacek/Hoffmann, Rainer/Krishnaswamy, Prakash: " Uncertainty management in automotive crash: from analysis to simulation" ASME, design engineering technical conference, Baltimore 2000.
- MARCZYK [2000b] Marczyk, Jacek " Validation of FE models using experimental data and Monte Carlo simulation." International conference on Monte Carlo Simulation, Monte Carlo 2000.
- MARCZYK [1999c] Marczyk, J. : " Principles of simulation base computer airded engineering" FIM publication, barcelona, 1999.
- RENCHER [1995] Rencher, A.C. (1995), " Methods of multivariate analysis" John Wiley and Sons, New York.