

Following Nature's Lead for Ultimate Design Efficiency The ACP Process as Applied to FSV

Akbar Farahani, Ph.D, ETA Inc.
Jody Shaw, U. S. Steel

Abstract

The shapes and configurations of nature are wildly complicated, non-intuitive and completely amazing. The shapes and forms found in nature in the structure of a tree, a human skeleton, insects and animals are truly the most efficient designs imaginable. By mimicking the flawless balance between structure and strength of nature's most efficient shapes, engineers can learn how to incorporate similar balance to product structural design for automobiles, aircraft and other systems.

The Accelerated Concept to Product (ACP) Process™ is a methodology which enables the structure of a product, such as the vehicle's body-in-white, to mimic "Nature's Way" [13]. Doing so creates the ultimate design efficiency, where structure and strength are perfectly balanced for the intended function.

ACP is a proprietary, performance-driven, holistic product design development method based on design optimization and incorporates the use of multiple CAE tools in a systematic process to generate the optimal design solution. This methodology provides solutions, which address the challenges facing the modern product development environment. It achieves this by synchronizing the individual facets of the product development process, resulting in an overall reduction in development costs and time to market.

Material selection and utilization, product performance requirements and manufacturing and assembly processes are all considered as early as possible in the design cycle. The resulting design offers a robust and highly efficient solution; which when combined with the strength and design flexibility of materials; facilitates significant mass reduction for the final design. This enables mass reduction, while realizing and even exceeding performance requirements. It begins with the progression from packaging space, to the initial design skeleton, to initial concept of the vehicle structure, through to final design concept [9].

The final design of the Future Steel vehicle (FSV) Program has been completed. During the final phase of program, FSV achieved 39% mass reduction and the new mass target was achieved in the design upon completion of the final optimization tasks, concluding the program[11,15,18].

The paper will cover the ACP Process, which enabled significant mass reduction results and will explain 3G (the balance of geometry, gauge and grade), 2G (grade and gauge) and 1G (gauge) optimization effects. Further, the results of the FSV mass reduction evolution will be disclosed [17].

The project involved optimization, from vehicle baseline to detailing the steel body structure concepts for the vehicles to meet aggressive mass targets of 177.6 kg, while meeting 2015-2020 crash, stiffness, NVH, and durability performance objectives and total life cycle Greenhouse Gas emissions targets. FSV's steel portfolio, including over 20 different AHSS grades representing materials expected to be commercially available in the 2015 – 2020 technology horizon, is utilized during the material selection process, while full vehicle analysis was used to determine material grade and thickness optimization [15,17]. Achievement of such aggressive weight reduction with steel will set a new standard for vehicle design approaches for the future.

1. Introduction

The automotive industry is facing numerous challenges today. The product design and development process includes multi-dimensional issues, which often contradict each other. A central challenge is the need for cost reduction to compete in the global market, while continuing to meet all new and existing requirements for quality and performance.

The cost reduction objective is challenged by a few factors, including aggressive fuel economy and emissions standards. Other factors include new crash safety requirements, increasing customer demands and expectations for quality and performance and the availability of new energy sources such as electric/hybrid vehicles, plug-in technologies and fuel cells. These requirements indicate that new approaches are necessary. Over the past 10 years, new technologies and techniques have been developed and implemented within industry research projects. The development and availability of some key enablers have also emerged, leading to a new design optimization based technique referred to as the Accelerated Concept to Product (ACP) Process. ACP views vehicle development in a completely *holistic* way. An approach such as this ultimately reduces the number of prototypes and tests, thereby reducing overall development costs [6]. The key benefits of ACP Process™ are shown in Figure 1.

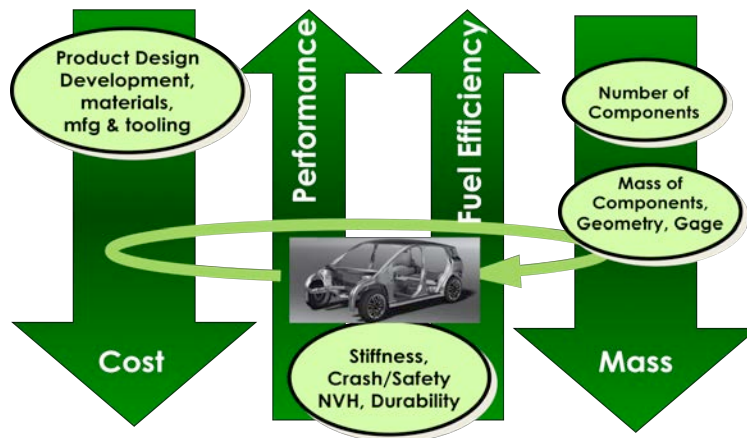

Figure 1: ACP Process™ Benefits

2. Background

WorldAutoSteel launched Phase 2 of its FutureSteelVehicle (FSV) program to show automakers how the latest and future steel grades and technologies can provide lightweight body structures for electrified vehicles. The program developed detailed, optimized design concepts for radically different steel body structures that address the unique requirements of electrified vehicles in production in the 2015-2020 timeframe. These steel body structure concepts (Figure 1), innovations which also can be applied to more conventional internal combustion engine-powered vehicles, achieved the aggressive mass target of 190 kg, while meeting global crash performance, NVH and stiffness objectives, as well as total life cycle greenhouse gas emissions targets[11].

The agent for these achievements is 97 percent use of High-Strength (HSS) and Advanced High-Strength Steels (AHSS) (Figure 3), of which nearly 50 percent reach into GigaPascal strength levels and are the newest in steel technology offered by the global industry. These are combined with advanced steel technologies and a new state-of-the-future engineering design approach ACP multidisciplinary Optimization (MDO) Process. Full details of this work can be found in the FutureSteelVehicle Phase 2 Engineering. The flexibility of steel with its variety of material properties can fully exploit the ACP optimization process and develop non-intuitive solutions for structural performance. The resulting optimized shapes and component configurations often mimic Mother Nature's own design efficiency, where structure and strength are placed exactly where they are needed for the intended function. FSV's steel portfolio is utilized during the material selection process with the aid of full vehicle analysis to determine material grade and thickness optimization [11,15].

Consequently, the FSV concepts are very efficient and lightweight. FSV's Battery Electric Vehicle (BEV) concept body structure (Figure 1) weighs 177.6 kg with a reduction in mass by more than 39 percent over the baseline ICE body, adjusted for a battery electric powertrain and 2020 regulatory requirements. FSV's A-/ B-Class Plug-in Hybrid Electric Vehicle 20 (PHEV20) vehicle structure weighs 175 kg, and C-/ D-Class vehicle Fuel Cell and PHEV40 versions weigh 201 kg.

This continuation of the FutureSteelVehicle design development process (Figure 2) includes **A**) an integration of final work performed in FutureSteelVehicle's Task 5 design optimization; **B**) continuance with Task 6 Integrated 3B Incremental Forming and Optimization [Refer to SAE Presentation] to prove

manufacturability of FSV's uniquely designed, "Nature's Way", front rail design; **C**) Final gauge optimization which re-integrated the front rail design into the full body structure and completed a final gauge optimization to take advantage of any further mass reduction opportunities due to design changes, while still meeting all crash/safety and stiffness requirements.

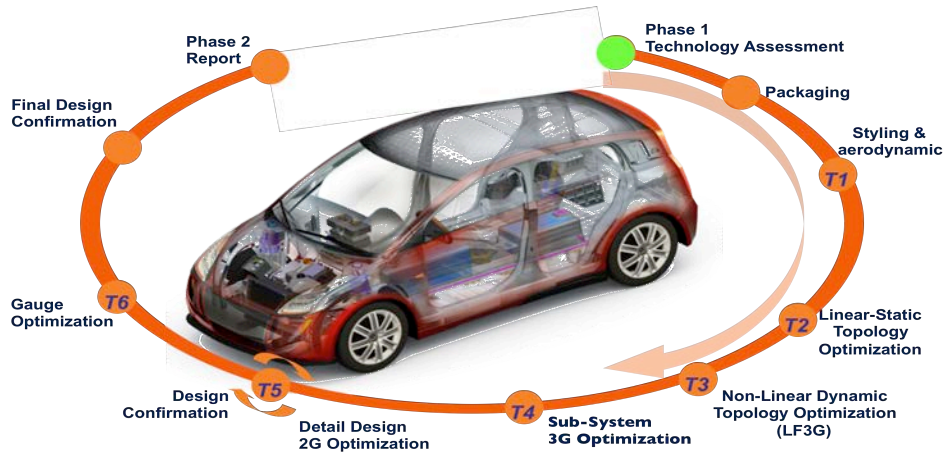

Figure 2: FSV Program ACP Process

The final gauge optimization is based on the following definitions:

- **T5 Final Design** = T5 FE Model, publicly announced in 2011 and reported in the FutureSteelVehicle Phase 2 Engineering and Overview Reports, May 2011, with a body structure mass of **188.4 kg**
- **T5 optimization Design** = design that was further optimized following the public announcement with a mass **188.0 kg**.
- **T6 Baseline** = T5 Final Design + T5 Design optimization + Updated design after forming optimization of Front Rail Sub-System.
- T6 Final Design = Achieve **176.8 kg**

3. The ACP Process™ Summary

In order to most effectively explore the design space (design volume, material and manufacturing process), while trying to reduce design cycle times, engineers are now using the ACP Process, which is an automated, multidisciplinary, optimization-based design process.

The ACP Process™ could be described as a "Search Engine", where it is unable to "invent", rather it searches the predefined available design space for the best possible solution which meets all of the design constraints. It uses computer technology to evaluate hundreds of design concepts, finding a set of acceptable design solutions that also contain the optimal or near-optimal design solution.

The holistic design process investigates the entire design space available and then defines the most robust design solution. The tools within ACP can greatly decrease the time required to identify a set of feasible, or even near-optimal, designs prior to building and testing the first prototype. Moreover, ACP can also compensate for the limitations of human intuition and provide design engineers with the freedom and power to seek creative solutions that are not obvious to even the most experienced engineers.

The process analyzes multi-disciplinary loading, based on topology optimization and geometry, grade and gauge (3G) optimization. Using multiple CAE tools; including modeling tools, application-specific tools, solver technology and optimization solutions; CAE, design and manufacturing are all synchronized. Once an optimal concept is identified, the ACP Process™ further generates the design, analyzes it and optimizes it using loading, manufacturing, material and cost constraints. It then outputs Computer Aided Design (CAD) data of an optimized concept design, suitable for detailed design and manufacturing[18].

3. Key Enablers

New advanced materials offer solutions for cost reduction, while addressing mass reduction and the need to meet the latest fuel economy and emissions, such as CAFÉ standards. Aluminum, composite materials and even magnesium are being aggressively investigated for mass reduction. Multi-material solutions are challenging the steel industry to enable additional mass reduction with steel for the vehicle body-in-white (BIW) and closures. This is the new direction in the automotive industry and FutureSteelVehicle program was initiated by WorldAutoSteel to respond to this challenge.

4. Body Structure Mass Targets

The mass target for the proposed A/B Class BEV body structure was 190 kg, which represents a 35% reduction over the baseline vehicle, setting a new goal for vehicle light weighting beyond the ULSAB-AVC program's 25% achievement [12].

5. FSV Vehicle and ACP Process Design

To meet the aggressive mass target the body structure design methodology combines an advanced steel materials portfolio and advanced steel manufacturing technology with the ACP Process™. It is applied to a clean sheet design targeted at the BEV powertrain. The SAE Vehicle Innovation Award-winning design optimization process was used to develop structures for FSV has the same energy and resource efficiency objective that mirrors what happens in nature, creating radically different, non-intuitive architectures optimized for the structure's function within the total system [13]. In addition to traditional technology solution selection criteria that consider mass and cost, the FSV program also considers technologies that reduce the total carbon footprint of the vehicle by applying a life cycle assessment (LCA) approach [14].

5.1 T1-Packaging and Computational Fluid Dynamic Simulation

After the Phase 1 technology assessment, studies of powertrain packaging, interior occupant space, ingress/egress requirements, vision/obscuration, luggage volume requirements, and ergonomic and reach studies of interior components established the component and passenger package space requirements. An exterior styling was applied to the packaging, followed by several computational fluid dynamic simulations, resulting in a drag coefficient of $C_d = 0.25$ [11](Figure 3).



Figure 3: BEV packaging theme and aerodynamic study

5.2 T2-Multi-Disciplinary (MD) Topology Optimization for the Vehicle Skeleton

As a first step in the ACP Process™, the objective of the topology optimization is to provide an initial structure based on the available structure package space as shown in Figure 4a. The first stage of the process is to develop and define styling, occupant and packaging requirements (Figure 4b). Remaining factors and requirements are then formed around these definitions. During topology optimization, the goal is to define the BIW of the vehicle. The BIW structure is formed based on where material is required in the design to withstand the major vehicle loads, such as body stiffness and crash loads. The ACP Process™ uses topology software and performs multidisciplinary load representations for all major loads that define vehicle architectures (crash and static).

The FSV program developed this structure by considering three longitudinal load cases, two lateral load cases, one vertical load case, bending and torsional static stiffness (Figure 4c). The topology optimization eliminated elements from a finite element mesh that represents the available structural design space, i.e. the volume within which structure can exist (Figure 4d). The elimination of elements is based on strain energy, thereby revealing the optimal load paths.

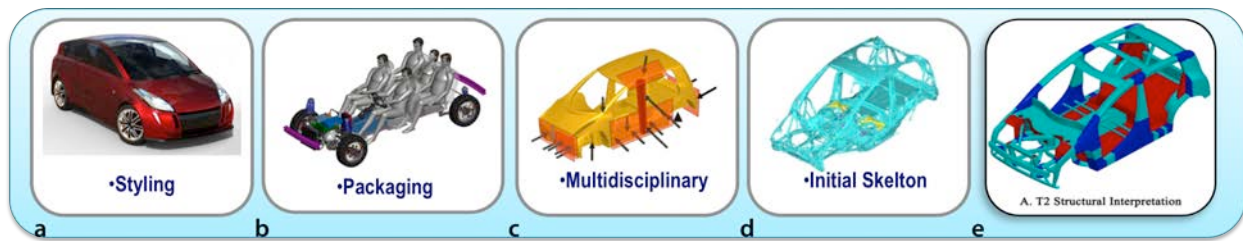

Figure 4: BEV structural design space, topology optimization results and interpreted CAD model

A target reduction or mass fraction is defined as a goal for the optimization. For this analysis, the topology optimization goals were 30%, 20% and 10% mass fractions. With the results obtained from the topology optimization, the geometry is interpreted into a CAD model (Figure 4e) using engineering judgment and special software tools. This model represents the initial skeleton geometry of the FSV and forms the basis of the next step in the optimization process [6].

5.3 T3-Low Fidelity 3G (Geometry, Grade and Gauge)

The goal of the ACP Process™ is to identify the optimal design solution within the available design space. At the heart of this process is 3G optimization method [1].

The process determines the optimal design solution while under multi-disciplinary loading conditions. In parallel, load paths, Geometry, Grade and Gauge (3G) are defined based on all of the possible material available. Figure 5 shows ACP's automated process. The system evaluates hundreds of design solutions automatically. The process starts with an approximated vehicle FE model, of which geometry is parameterized. This initial geometry begins the process and is evaluated, then new design solutions are generated using changes in geometry, grade and gauge (3G optimization). The design team monitors the design changes when these new solutions are found. The process continues until the objectives are met (meeting minimum mass and performance targets). Several design solutions can be found and after further study the best design concept is selected [8,9,10,17].

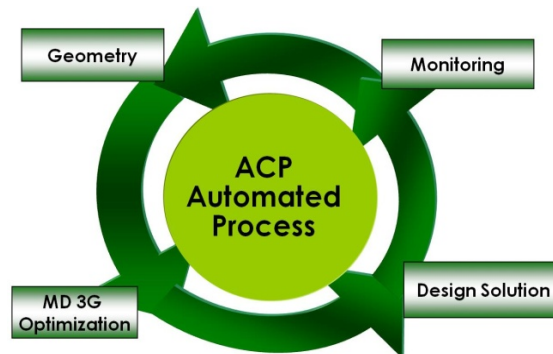

Figure 5: ACP Process™ – A Fully Automated Process

Though the topology optimization was able to provide an initial starting point for the FSV's geometry, it is limited by its static approximation of dynamic crash loads and does not consider grade variations of the sheet metal within the structure. Therefore, the load path optimization is moved to the dynamic design domain (using LS-DYNA® Finite Element Analysis Software) combined with a multidisciplinary optimization program (HEEDS® or LS-OPT Design Optimization Program), which also addresses a low fidelity optimization of the major load path cross-sections, grades and gauges of the body structure. The output is designated the Low Fidelity Geometry, Grade and Gauge (LF3G) optimization.



Figure 6: a-LF3G optimization, b-reference body structure and c-structural sub-systems

The final FSV body structure attained from the LF3G optimization is shown in Figure 6a, which does not represent section shapes that can necessarily be manufactured and assembled nor are they structurally efficient from a topography perspective. To create the required reference body structure, the LF3G body structure was combined with engineering judgment of current benchmarked designs (Figure 6b). This reference assumes typical manufacturable sections and joint designs combined with extensive use of AHSS achieving a calculated mass for the sheet steel baseline of 218 kg. Based on load path mapping, seven structural sub-systems were selected for further optimization using a broad bandwidth of manufacturing technologies [18](Figure 6c).

5.4 T4-3G Optimization of Sub-Systems

After the full-vehicle system load path and general section geometry, the ACP Process™ determines grade and gauge and manual design modification for high level manufacturability is performed. The full system is ready for detailed design for a selection of manufacturability processes, materials and gauges.

To achieve this, the full-system would be decoupled into major load carrying sub-systems, in which they define the characteristics of the vehicle such as front rail and rear longitudinal, shotgun, rocker, B-pillar and side roof rail [1]. The ACP Process™ identifies the optimal design solution within the available design space and details design variables based on high fidelity 3G optimization for each of sub-systems [2]. The material of each subsystem with its manufacturing process will be the output for the next step of the ACP Process™ [9,10].

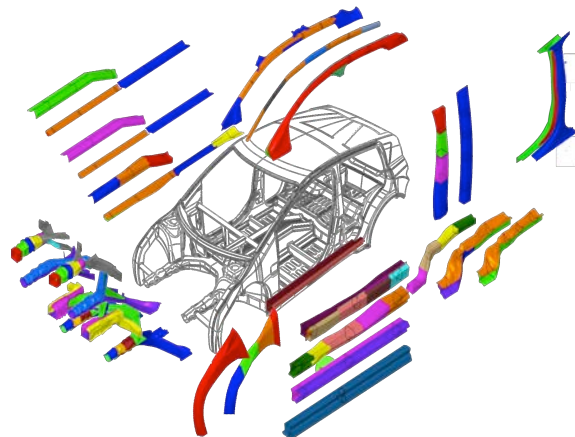

Figure 7: T4 Sub-System Optimization Selection

5.4.1 BEV Sub-Systems Selection

Steel's flexibility enabled the achievement of a variety of solutions for the selected sub-systems. Within this portfolio of solutions are applications that all vehicle manufacturers and segments will find relevant. These solutions demonstrate dramatically reduced mass and GHG emissions in seven optimized sub-system structures, at lower or comparable costs to conventional solutions.

The next step in the FSV design process was to select the most appropriate sub-system options from those developed through the design methodology. The programme engineering team made these decisions based on the following factors: Mass, Cost and LCA (Life Cycle Assessment).

Beyond these criteria the selection process considered the technology time horizon to be within the 2015-2020 timeframe. It also considered the joining compatibility between the technologies. Hence, the FSV sub-systems recommendations were divided into three categories, based on the level of difficulty of the manufacturing technology and the time period during which these technologies would be feasible for high-volume production (Figure 7).

5. T5-Confirmations, Validation and Detailed Design for Production

After the major sub-systems were designed by the ACP Process™, the components were modified by manual design manipulation based on selected manufacturing processes. The new vehicle architecture was then integrated into the full-vehicle system based on the ACP selections of materials and manufacturing processes. A full vehicle BIW and closures structure was designed in detail (joining, interactions, sub-assemblies) using design specifications and manufacturing evaluations to meet vehicle performance targets[3]. The resulting design represented the most robust load path, geometry, gauge and grade of the materials on the vehicle.

During this stage, the engineering team gets confirmation of the total design solution, incorporating all load cases of BIW and closures for durability, crash/safety, NVH and ride and handling. A sensitivity study is done and minor design modifications are made. The vehicle model is validated virtually and is prepared for prototyping and testing [8].

6. Body-in-White Design, Assembly & Performance of FSV BEV

6.1 FSV BEV final lightweight body-in-white structure

The Battery Electric Vehicle body-in-white (BIW) structure achieved a mass savings of 101 kg (-35%) compared to the baseline body structure mass as shown in Table 1. The mass reduction was realized through the use of advanced and ultra high-strength steel grades combined with steel technologies such as roll forming and multi-thickness blanks. Even though there is a cost premium associated with the use of higher-grade steels, the weight savings balanced the overall costs of manufacturing and assembly. The BEV body-in-white structure, the different grades of steel and the steel grade distribution are shown in Figure 8.

Body-in-white	FSV BEV
Benchmark Mass (kg)	290
Target Mass (kg)	190
Achieved Mass (kg)	187.7

Table 1: FSV program achievement

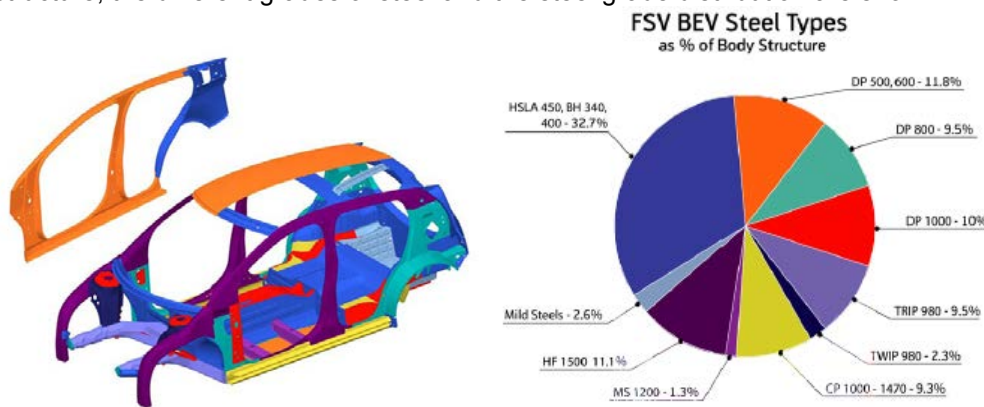

Figure 8: FSV BEV body-in-white steel grades used and distribution

6.2 Forming Simulation & Joining Issues

Figure 9 illustrates the different manufacturing technologies implemented for the FSV body-in-white structure. The main technologies include cold stamping of monolithic and laser welded blanks, hot stamping and roll forming.

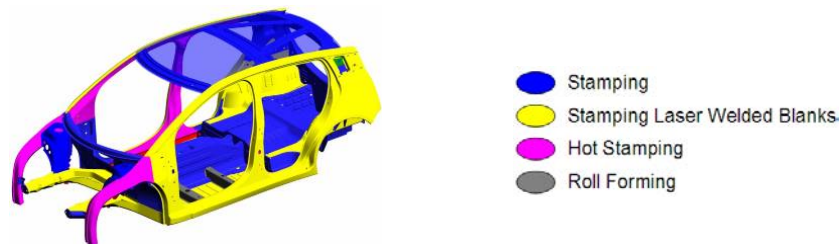

Figure 9: FSV body-in-white manufacturing processes

Single step simulation was done on all the parts of the BIW. Parts that play an important role in crashworthiness like B-pillars, shotguns and roof rails were made through a hot-forming process. In that case, a single step simulation with IF260/410 material parameters was used. Some parts, which have complicated shapes like front rails, body side outer and rear rails require the incremental analysis method for predicting the manufacturing results more accurately. In Figure 10, the results of the incremental analysis of the body side outer made with DP600 0.8 mm and BH220 0.6 mm for the rear parts are shown. Although some minor changes are needed, it proves that the stamped component design is safe.

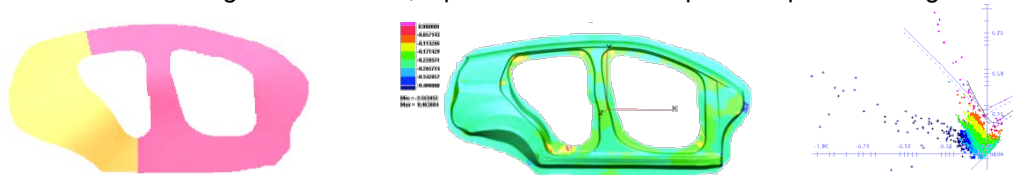

Figure 10: FSV body side outer incremental analysis results

Some of the most common assembly joining techniques were considered. The joining processes selected for the FSV body-in-white assembly were resistance spot welding, laser welding, laser brazing, roller hemming and adhesive bonding. Figure 11 and Table 2 below detail the quantity for each joining technique used:

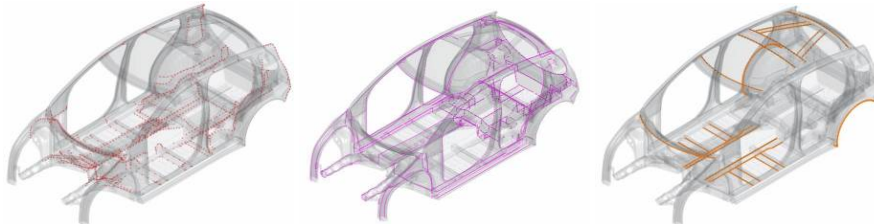

Figure 11: Joining techniques used for FSV BIW assembly

Joining Techniques	Total
Total number of Spot Welds	1001
Total Length of Laser Welds	87.26 m
Total Length of Adhesive	19.11 m

Note:
 - Laser Welds includes: Laser Welding (Remote), Laser Brazing
 - Adhesive includes: Structural adhesive (1-Part Epoxy), Anti-flutter, Hem adhesive

Table 2: Joining techniques details used for FSV BIW assembly

Specific attention has been paid to the design in order to avoid impossible welding stack-ups such as mild steel 0.6 mm - mild steel 0.6 mm - PHS 2.0 mm.

6.3 Crashworthiness, Stiffness and NVH

The detailed design of the FSV body structure was supported by computer aided engineering (CAE) analysis, to verify the structural performance. The CAE analysis results were compared to the FSV targets to quantify the performance of the FSV body structure in terms of static stiffness, crashworthiness and durability. The full CAE results for crashworthiness (IIHS, NCAP US and ECE/EU), durability and NVH are included in the full report.[15,18].

7. T6-Full Vehicle System MD 2G Optimization with Detailed Manufacturing

T6 final optimization concluded the design process of FSV program. T6 multidisciplinary gauge optimization considered the detail design effects based on T5 final design. This means the optimization will include effects of continues joining and final manufacturing selections. The design process finalized the design by reducing weight of BIW due to joining efficiency and taking mass off from possible inefficiencies due to design modifications, while meeting all vehicle performance targets in terms of crash, stiffness and low frequency NVH.

7.1 T6-Formability Study Based on Optimization Technology

The manufacturing challenges of AHSS are a common theme today requiring geometry design concessions that compromise true design efficiency. There are many initiatives in the automotive and steel industry to expand the formability design space and address improvements in design efficiency, such as the development of 3rd generation AHSS, and the Auto/Steel Partnership's non-linear strain path project and AHSS stamping project.

In the final stage of T6 design extensive formability study continued for all parts in FSV BIW, using one step and incremental formability method. This process brought most of parts to highly formable with no or minimum challenges for manufacturing. In particular special attention was given to the front longitudinal rail, because of its non-uniform and convoluted geometry. To address this challenge WorldAutoSteel and ETA initiated and developed a forming process based on optimization technology that enable manufacturers to make parts formable (remove large strain, wrinkling, cracking and thinning) with minimum engineering effort while one use AHSS with very thin gauges [19]

Integrated Incremental **3B** (**B**ead, **B**lank Geometry and **B**inder Pressure) Forming and Crash **Optimization** approach balances forming parameters such as draw Bead force and geometry, Blank shape and size and Binder pressure and then perform gauge optimization of the product itself to create the lightest, most structurally and cost efficiency design possible that meets the vehicle performance targets. It achieves this by optimizing the component design for formability while simultaneously validating it's in vehicle crash performance [19].

7.2 T6-Final Results Summary

The following is a summary of the T6 multidisciplinary gauge optimization task. The design was started with T5 final design, updated with T5 optimization grade and gauges. Finally this design was updated with T6 new formable longitudinal (TRIP 800 grad, see Figure 11).

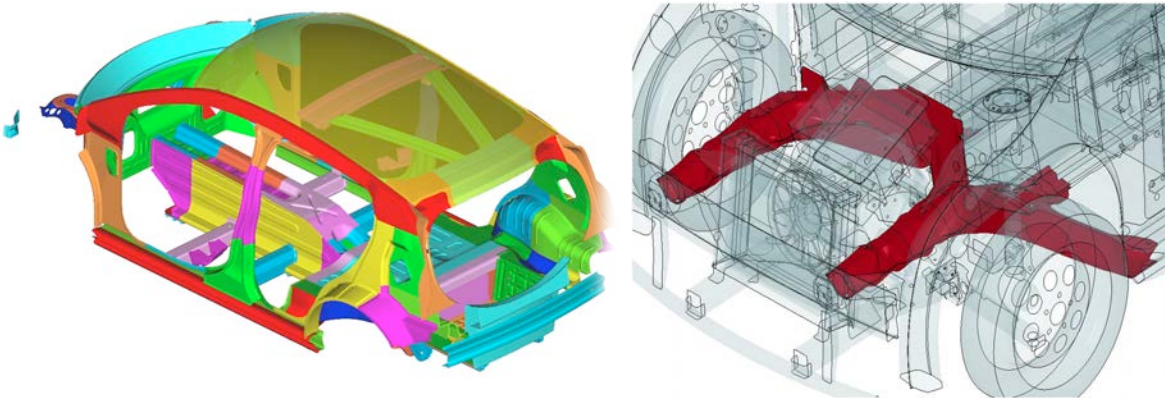

Figure 11: FSV parts that were updated (Gauge and Grade) according to T5 Design and Formability

The updated design summarized above became the T6 Baseline vehicle used for the final T6 gauge optimization. With the above incorporated updates, the T6 Baseline body structure mass was reduced to 179 kg. The T6 Baseline exhibited significantly better crash performance than the T5 Final version in several of the crash load cases, indicating potential for additional mass saving.

Table 3 summarize final T6 multidisciplinary gauge optimization indicating 11.6 kg additional mass saving. The new BIW mass reduced to 176.8 kg, improving 35% of T5 mass reduction to 39% compare to the FSV target vehicle.

Design	Mass kg	NCAP	Front ODB	IIHS Side	Side Pole	IIHS Rear	IIHS Roof	Bend.	Torsion (kN-m/deg)
Targets	<188	38 g	Good	125mm	125mm	Pass	37.5kN	12	20
T5-Final	188.4	39.7	Good	142	150	Good	55	15.5	19.6
T6-Final	176.8	37.8	Good	152	138	Good	44.5	14.2	19

Table 3

At this stage in the expectation is that the designed vehicle system should meet all vehicle performance requirements, as well as obtaining above 39% mass reduction, based on vehicle class and mass targets.

8. Conclusion

In conclusion, by applying the ACP Process™ and incorporating the use of unique optimization tools, advanced materials and manufacturing technology can addresses many of the current product development challenges which face the automotive industry today.

Figure 12 shows the FSV mass evolution using ACP process during vehicle design maturity. The mass evolution curve indicates that design process effectiveness by use of appropriate (required) geometry and grade and gauges where it is needed. Indeed vehicle BIW mass reduces while vehicle performance improves. This graph also indicates the contribution of advanced material, new manufacturing process and continues joining can push the mass of BIW to its new limits.

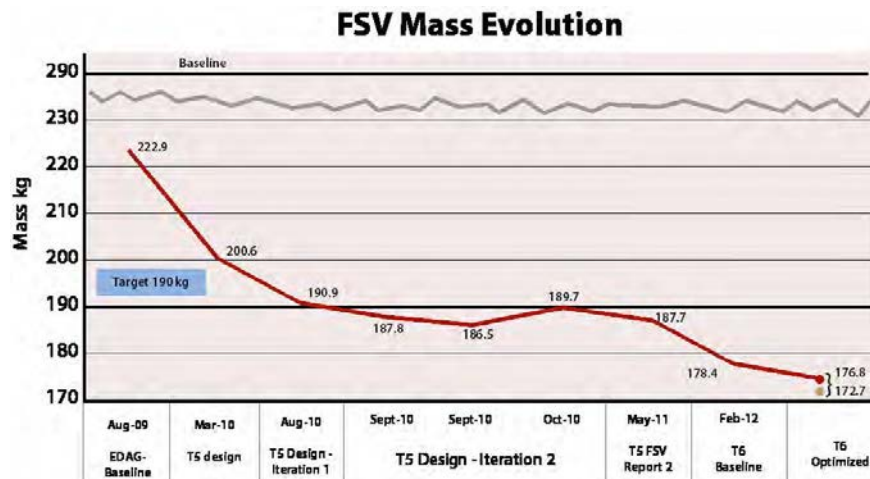

Figure 12: FSV Mass Evolution from T1 to T6

The FutureSteelVehicle project used the ACP Process™ combined with an expanded portfolio of steels and manufacturing technologies that foretell the future of steel grades readily available in the 2015 to 2020 time frame. The design methodology used to develop the FSV body structure utilized modern computer-aided optimization techniques and helped the program to achieve an optimal mass efficient design. Key achievements are:

1. Employs state-of-the-future design innovations that exploit steel's versatility and strength
2. Achieves 39% BEV body structure mass savings compared to benchmark ICE vehicle
3. Uses 97% High-Strength (HSS) and Advanced High-Strength Steel (AHSS), of which nearly 50% is over the 1000 [MPa] strength steels
4. Enables 5-star safety ratings
5. Reduces total Lifetime Emissions by nearly 70% compared to ICEg
6. Reduces mass and emissions at no cost penalty

9. References

1. J.M. Madakacherry, D. Eby, M. B. Isaac, A. Farahani, C. Bruggeman and R. C. Averill "A Process of Decoupling and Developing Optimized Body Structure for Safety Performance," "10th European LS-DYNA Conference." March 18, 2004.
2. D.J. Eby, R.C. Averill, E.D. Goodman and R.S. Sidhu, "Shape Optimization of Crashworthy Structures," *LS-DYNA User's Conference*, Dearborn, MI, May 20-21, 2002.
3. A. Farahani, R.C. Averill and R. Sidhu, "Design Optimization of Hydroformed Crashworthy Automotive Body Structures," *CAD-FEM Users' Meeting*, Berlin, Potsdam, Germany, November 12-14, 2003.
4. Auto Steel Partnership, "Future Generation Passenger Compartment", (FGPC) Phase 1, November 2007
5. Auto Steel Partnership, "Future Generation Passenger Compartment", (FGPC) Validation, November 2009
6. D Reed, T. Seel, D. Baskin and A Vollmer, "Lightweight Body Section Targeting & Material Selection Process", Great Designs In Steel (GDIS) May 2008
7. A. Farahani, J. Shaw, "Future Generation Passenger Compartment" Great Designs in Steel (GDIS), May 2007
8. J.Polewarczyk, "Future Generation Passenger Compartment- Validation Phase", Great Designs in Steel (GDIS) May 2009
9. A Farahani, J. Shaw", Highly Optimized Longitudinal Rail Achieving 45% Mass Reduction", Great Designs in Steel (GDIS), May 2009
10. J. Shaw, H. Singh and A. Farahani, "Future Steel Vehicle", Great Designs in Steel (GDIS) May 2010
11. EDAG AG, (2009). *FutureSteelVehicle Phase 1 Engineering Report*, www.worldautosteel.org/Projects/Future-Steel-Vehicle/Phase-1-Results-Phase-2-Launch.aspx
12. Porsche Engineering Services, Inc., (2002). *ULSAB-AVC (Advanced Vehicle Concepts) Engineering Report*, Retrieved from WorldAutoSteel website, www.worldautosteel.org/Projects/ULSAB-AVC.aspx
13. Engineering Technology Associates, Inc. (ETA), (2009). *Methodology Used in Future Steel Vehicle Wins SAE Vehicle Innovation Competition*, www.theautochannel.com/news/2009/12/18/459143.html
14. Geyer, R., (2007). *Life Cycle Greenhouse Gas Emission Assessments of Automotive Material: The Example of Mild Steel, Advanced High Strength Steel and Aluminum in Body in White Applications*, www.worldautosteel.org/Projects/LCA-Study.aspx
15. EDAG AG, (2010). *Phase 2 FutureSteelVehicle Steel Technology Assessment and Design Optimization Engineering Report* www.worldautosteel.org/Projects/Future-Steel-Vehicle/FSVInterimReport.aspx
16. J. Shaw, M. Lambriks, Y. Kuriyama, "Achieving a Lightweight and Steel-Intensive Body Structure for Alternative Powertrains", SAE 2011 (11M-0308)
17. J. Power, S.Laxman, A. Farahani, H.Sharifi, "FSV Design Methodology: Detail Design Concept using 3G Optimization", SAE 2012 (2012-1345)
18. A. Farahani, M.Lambriks, J.Shaw,"The ACP Process™ Applied to the **FutureSteelVehicle** Project: The Future of Product Design and Development", " 8th Annual European LS-DYNA use Conference", May 2011.
19. J. Shaw, A.Farahani," FSV Design Methodology:3B Forming Optimization, Expanding Forming Window for AHSS", SAE 2012

Keywords:

Optimisation, FutureSteelVehicle, ACP, WorldAutoSteel, ETA, Design Process, Synchronization, Advanced High Strength Steels